

# EASY DIY POWER PLAN

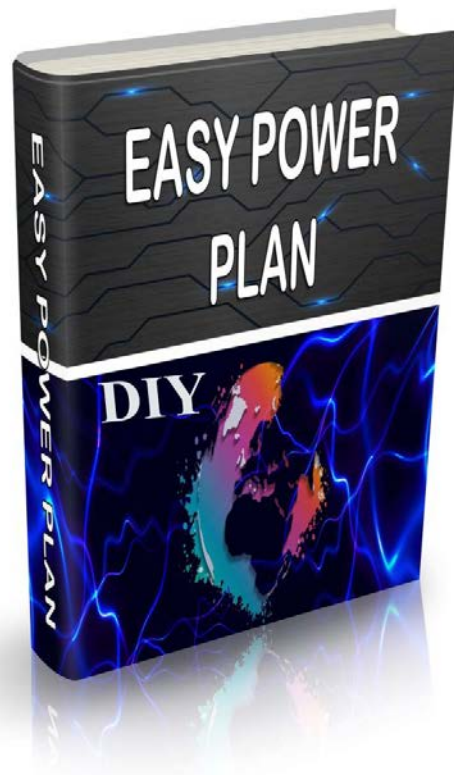

# Table of contents

Disclaimer.....	3
Introduction.....	5
List of components.....	22
DC Motor 12-volt.....	22
Gears with Sprocket Chains.....	27
Flywheel.....	28
Rotors.....	29
Alternator.....	32
The Generator.....	37
The Switch.....	64
The Inverter.....	64
Battery.....	65
Conclusion.....	65
List of tools.....	67

## **DISCLAIMER:**

The content and the product for sale is based upon the author's opinion and is provided solely on an "as is" and "as available" basis. All products from easydiypowerplan.com are strictly for informational purposes only and should not to be construed to be professional advice from us. We do not guarantee the accuracy or completeness of any of the information provided, and is not responsible for any loss resulting from your reliance on such information. We do not assume any responsibility for errors, omissions or contrary interpretation of the subject matter herein via this website or in the product. Under no circumstances will we be liable or responsible for any direct, indirect, incidental, consequential (including damages from loss of business, lost profits, litigation, or the like), special, exemplary, punitive, or other damages, under any legal theory, arising out of or in any way relating to our website, your website use, or the content, even if advised of the possibility of such damages. This is an online information service, subject to your compliance with the terms and conditions set forth below.

### **Copyright, licenses and idea submissions.**

The entire contents of the site are protected by international copyright and trademark laws. The owner of the copyrights and trademarks are easydiypowerplan.com, its affiliates or other third party licensors. You may not modify, copy, reproduce, republish, upload, post, transmit, or distribute, in any manner, the material on the site, including text, graphics, code and/or software. You may print and download portions of material from the different areas of the site solely for your own non-commercial use provided that you agree not to change or delete any copyright or proprietary notices from the materials. You agree to grant to easydiypowerplan.com a non-exclusive, royalty-free, worldwide, perpetual license, with the right to sub-license, to reproduce, distribute, transmit, create derivative works of, publicly display and publicly perform any materials and other information (including, without limitation, ideas contained therein for new or improved products and services) you submit to any public areas of the site (such as bulletin boards, forums and newsgroups) or by e-mail to easydiypowerplan.com by all means and in any media now known or hereafter developed.

### **Limitation of liability**

In no event will easydiypowerplan.com be liable for any incidental, consequential, or indirect damages (including, but not limited to, damages for loss of profits, business interruption, loss of programs or information, and the like) arising out of the use of or inability to use the service, or any information, or transactions provided on the service, or downloaded from the service, or any delay of such information or service. Even easydiypowerplan.com or its authorized representatives have been advised of the possibility of such damages, or any claim attributable to errors, omissions, or other inaccuracies in the service and/or materials or information downloaded through the service. Because some states do not allow the exclusion or limitation of liability for consequential or incidental damages, the above limitation may not apply to you. In such states easydiypowerplan.com liability is limited to the greatest extent permitted by law. Any rights not expressly granted herein are reserved. Any rights not expressly granted herein are reserved.

### Additional information

We are not professional writers or photographers and didn't always have opportunity to document or photograph every step of development. Therefore, please take the level of engineer/electrical experience required to build a Easy DIY Power Plan very seriously as we are giving these to you under this premise. You will discover the advanced level of knowledge of mechanical/electrical processes needed quickly enough. The correct construction of the Easy DIY Power Plan requires patience and careful thought. We made several mistakes in development and have given here the steps that were successful. You will probably still make mistakes – and these will be your greatest learning opportunities as you gain more knowledge about this type of energy.

Before beginning to build, consider how much you would like to outsource to one of the cottage industry community units (CICUs) near you! In the US we recommend Polaris for the steel stator/rotor construction, and Torelco for toroidal winding. As FTW continues to roll out the distribution plan, and more connections across the world are made, we think CICUs will be commonplace and hence, P Easy DIY Power Plan parts accessible (many people will be making them!)

When website URLs were available we provided links for the person reading this online. You may certainly use your own sources for materials but it is imperative you do not alter the instructions/parts herein if you are building a Easy DIY Power Plan. (We know with increased knowledge you will discover many applications for this technology.) When photographs can be shown to help you visualize a process, they will be provided. Please remember, we are not professional manual writers. What we offer you here is our gift to humanity – but it comes with great responsibility. Learn as much as you can, use discernment and wisdom, share freely, and you will be privileged to know the secrets of energy creation from the quantum field.

**WARNING!** We are not responsible for anything in these plans; you build at your own risk.

# Introduction

Human civilization has started realizing how much harm they have already caused to the environment, not to mention the costs involved; and when it comes to take a stand against these environmental problems, the focus shifts to the use of alternative energy sources. Have you ever wondered what Alternative Energy Sources are? And why are they supposed to help us sustain? Alternative sources of energy are the ones which do not cause any undesirable consequences to the environment, are renewable and are free!

Alternative energy sources can be implemented for houses, for cars, factories and any other facility you can imagine. Scientists around the world are researching on developing and discovering new Alternative Energy Sources so that the growing energy needs of human population can be met more easily, safely and efficiently.

The Easy DIY Power Plan does exactly that. It uses one of the basic materials in nature to convert its power into clean, usable energy. It has been around for thousands of years and its properties haven't changed. It's the magnet.

## **What are Alternative Energy Sources?**

Alternative energy encompasses all those things that do not consume fossil fuel. They are widely available and environment friendly. They cause little or almost no pollution. There have been several alternative energy projects running in various countries to reduce our dependence on traditional fossil fuels. There are many impressive options that you can take into consideration. Here in you will learn more about alternative energy sources that you can take into consideration.

# Solar energy: What is it and how does it work?

The sun does more than for our planet than just provide light during the daytime – each particle of sunlight (called a photon) that reaches Earth contains energy that fuels our planet. Solar energy is the ultimate source responsible for all of our weather systems and energy sources on Earth, and enough solar radiation hits the surface of the planet each hour to theoretically fill our global energy needs for nearly an entire year.

Where does all of this energy come from? Our sun, like any star in the galaxy, is like a massive nuclear reactor. Deep in the Sun's core, nuclear fusion reactions produce massive amounts of energy that radiate outward from the Sun's surface and into space in the form of light and heat.

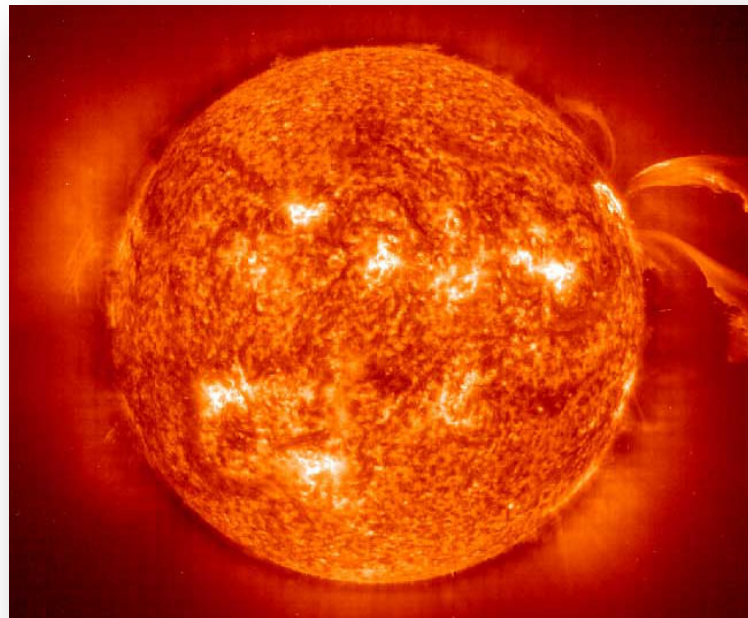

Solar power can be harnessed and converted to usable energy using photovoltaics or solar thermal collectors. Although solar energy only accounts for a small amount of overall global energy use, the falling cost of installing solar panels means that more and more people in more places can take advantage of solar energy. Solar is a clean, renewable energy resource, and figures to play an important part in the global energy future.

Solar is the first energy source in the world. It was in use much earlier before humans even learn how to light a fire. Many living things are dependent on solar energy from



plants, aquatic life, and animals. Solar is mostly used in generating light and heat. The solar energy coming down to the planet is affected by the orbital path of the sun and its variations within the galaxy. Besides, it is affected by the activity taking place in space and on the sun. It was this energy that is believed to have been responsible for the breaking of ice during the ice age, which creates the separation of lands and sea.

Solar energy is one of the alternative energy sources that is used most widely across the globe. About 70% of the sunlight gets reflected into space and we have only 30% of sunlight to meet up our energy demands. While solar energy is used for producing solar energy, it is also used for drying clothes, used by plants during the process of photosynthesis and also used by human beings during winter seasons to make their body temperature warm. Solar energy can be extracted either by Solar Thermal or using Photovoltaic (PV) Cells. Learn more about these methods here.

There are two kinds of solar energy the active solar energy and passive solar energy. Passive solar energy uses duration, position and sun's rays intensity to its advantage in heating a particular area. It also uses it to induce airflow from an area to the next.



Active solar energy uses electrical technology and mechanical technology like collection panels in capturing, converting, and storing energy for future use.

Solar energy does not create any pollution and is widely used in many countries. It is a renewable source of power since the sun will continue to produce sunlight all the years. Solar panels, which are required to harness this energy can be used for a long

time and require little or no maintenance. Solar energy proves to be ineffective in colder regions that don't receive good sunlight. It cannot be used during the night and not all the light from the sun can be trapped by solar panels. Solar energy advantages are much more than its disadvantages which make it a viable source of producing alternative energy.



# A short history of photovoltaic solar power

Humans have always made use of solar energy. When man's earliest ancestor realized that a patch of sunlight was warmer than the shade, or that rocks heated all day by the sun remained warm long into the night, solar energy was being used.



Ancient Roman structures were routinely built with south-facing windows to gather in the warmth of the sun. So many Roman residences and public buildings made use of passive solar heating that the imperial enactments of the Justinian Codex, a part of the Corpus Juris Civilis issued between 529 and

534 by order of the Roman

Emperor Justinian I, addressed individual citizens' sun rights.

Passive solar design is still popular today. Whether it is as simple as determining on which wall to place a barn entrance or as complex as the glass material selection and window placement for a multimillion-dollar design, architects and craftsmen continue to design and build structures that take full advantage of the sun's warmth and light. The only thing new about solar daylighting or passive solar heating is the name.





All early attempts to harness solar energy focused on heat. This is understandable because the warmth of sunlight is an obvious, tangible property. The basis for the Industrial Revolution was the steam engine, and so early works with solar energy attempted to concentrate the sun's heat to produce steam. In 1767, a Swiss scientist named Horace-Benedict de Saussure constructed an insulated box with an opening covered by three layers of glass. This device is generally considered to have been the world's first solar collector, and it could reach internal temperatures of 230 degrees Fahrenheit. In the 1830s, Sir John Herschel took one of these devices, commonly known as a Saussure's oven, on his South Africa expedition to cook food.

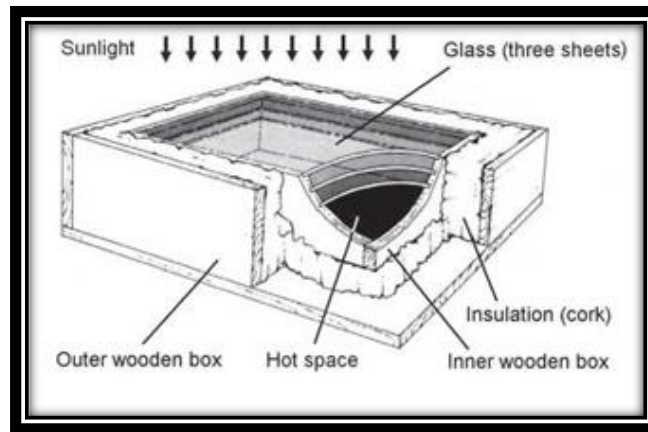

Solar economizers or concentrators are still widely used today. Systems of mirrors and lenses focus sunlight onto reservoirs of thermal transfer fluids to produce steam, control building temperatures, or heat saline storage ponds. Unlike Saussure's ovens, modern solar concentrators reach temperatures in the thousands of degrees. To the average consumer, however, heat isn't energy. Electricity is energy. Solar power is considered energy only when it is converted to useable electricity.

The first step in converting sunlight to electricity occurred in 1839 when a French scientist named Edmond Becquerel exposed two electrodes in an electrolyte to sunlight. He observed an increase in electrical current that he could not explain. This was a defining moment in the history of solar power. Although he did not understand the physics behind his observation, Becquerel is credited with first observing what is now known as the photovoltaic effect. It was a scientific curiosity, but it was not put to little practical use for many years.

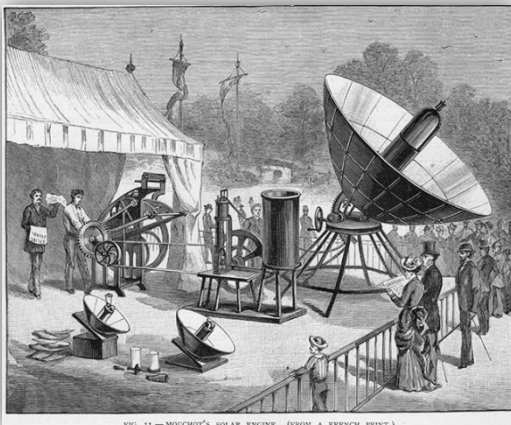

Investigation of solar energy has long been tied to the price structure and supply of other fuels. In the 19th century, France purchased coal to fuel its industrial growth from England. A French inventor named Augustin Mouchot believed that the supply was exhaustible and, in the hands of the English, unreliable. In 1860, he began building upon Saussure's oven and created a water-filled container that was enclosed in a glass envelope. Exposure to sunlight concentrated heat inside the glass envelope and caused the water to boil in the container. By connecting a small steam engine to this device, Mouchot created the first solar-powered steam engine.

His work was inventive, practical, and financially supported by the French government. Unfortunately for the history of solar power, France soon negotiated a new deal with England for cheaper coal and more reliable deliveries. Mouchot's work was no longer viewed by the French monarchy as a priority for that country, and his funding was discontinued. Without financial backing, his work fell to the wayside.

Other scientists continued to toy with the curious property discovered by Becquerel, and in 1873 another important advance in solar energy occurred when Willoughby Smith discovered that selenium was a photoconductive material. William Grylls Adams and Richard Evans Day experimented further with selenium. They were not able to produce sufficient quantities of electricity to do any useful work, but by 1876 they were able to demonstrate, for the first time, that a solid material with no moving parts could be used to convert sunlight directly into electrical energy.

An American inventor, Charles Fritts, used their discovery to create solar cells from selenium wafers ten years later. These primitive cells converted less than two percent of the available sunlight into electricity, but this was still a tremendous achievement at the time.



Most researchers at that time were also looking for a way to store electricity for later use. It was inconvenient to operate a conventional generating facility in the middle of the night, and it was impossible to collect sunlight at night. In 1904, Henry Willise constructed two large solar generators and storage facilities in California. His facilities were the first to use power at night that had been generated through solar photovoltaics during the daylight hours. His facilities were expensive to operate,

however, and his company went bankrupt without inspiring any additional innovations.

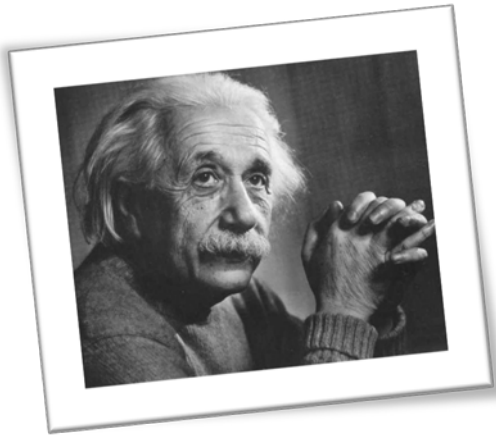

Albert Einstein contributed a tremendous advancement in solar energy when he published the explanation of the photoelectric effect in 1905. With his explanation of the phenomenon, physicists began to experiment with photovoltaics and to design materials that they predicted would demonstrate a photovoltaic effect.

Although early solar cells used selenium, the material most widely used in solar cells today is silicon. Jan Czochralski, a Polish scientist, is credited with the discovery of the technique for growing single-crystal silicon in 1916. Many other materials also exhibit photovoltaic effects. Cadmium sulfide, for example, was shown in 1932 to produce a current upon exposure to sunlight, and cadmium sulfide solar cells were used by the French government to power remote schools in Algeria.

Photovoltaic materials produce electricity in differing amounts according to the band gaps of the materials and the wavelengths of light to which they are exposed. In 1953, an American Chemist by the name of Dan Trivich published a series of theoretical calculations that predicted the efficiencies of various materials as solar cells based on their bandgap widths and the spectrum of the sun.

The first real solar photovoltaic cell was created at Bell Laboratories a year later when Daryl Chapin, Calvin Fuller, and Gerald Pearson created a silicon crystal cell that could convert ordinary sunlight into a sufficient quantity of usable electricity to power equipment. The original cell had an efficiency of only four percent, but subsequent models reached 11 percent efficiencies.



In 1956, the United States began to develop solar cells for satellites. N-p junction silicon cells were invented by U.S. Signal Corps Laboratories in 1958. This design was much more resistant to radiation damage and was critically important for use in space, and the Vanguard I space satellite used a p-n junction silicon solar cell that produced less than one watt to power its communication radios. Explorer III, Vanguard II, and Sputnik-3 were all launched in 1958, and all featured p-n junction photovoltaic solar cell technology.

Silicon solar cells first became commercially available in 1959. By 1960, efficiency had been increased to 14 percent, and Bell Telephone Laboratories launched the Telstar telecommunications satellite, which featured a 14-watt solar-array panel, in 1962. By 1966, NASA satellites featured 1-kilowatt photovoltaic arrays.



Although solar cells were available commercially at this time, they were by no means cost-effective. Electricity produced by conversion of solar energy typically costs \$100 per watt at this point. The production price dropped to \$20 per watt in the 1970s due to advancements made by Dr. Elliot Berman. His inventions were used at off-grid locations where power was required for emergency or safety applications.

In 1972 the world's first laboratory dedicated to the advancement of photovoltaic energy was founded at the University of Delaware. Thin-film PV systems were studied here. Silicon crystals are expensive to produce. One line of PV research has been the development of amorphous silicon photovoltaic cells.

These cells lack a crystalline structure and are much less efficient than silicon crystal solar cells, but they are also much cheaper to produce. Because they are cheaper, more cells can be produced and used. The economy of scale overcomes inefficiency, and solar electricity can be produced by thin-film amorphous cells at lower costs per watt than through the use of crystal silicon PV cells.

History shows that advances in solar energy have been sporadic. In most cases, advances are seen to occur when conventional energy costs soar or when supplies are questioned. The advances made in the 1970s, for example, can be seen to correspond to the oil crisis of that same period. Mouchot's solar steam engine was financed when France feared England would limit technological expansion by limiting the availability



of coal. When costs drop, public and governmental interests in solar power generally wane. That paradigm, however, may be shifting.

Governments have made an enormous investment in utility-scale solar plants during the past few years. Uncertainty about the Middle East, where much of the world's petroleum supply is concentrated, has increased governmental interest in alternative fuel sources. Unlike previous flirtations with solar power, however, the cost may not be the ultimate factor. Global warming phenomena and concerns over greenhouse gas emissions associated with energy production have also driven solar investments in recent years.

Current solar energy research focuses on cheaper methods of producing silicon solar cells, more effective means of storing solar energy, new super-thin copper-indium-gallium-selenide solar films, and the use of dye-laden glass or plastic plates to focus photons onto solar panels. These ideas may ultimately result in transparent materials that will turn every window into a solar panel, new construction materials that will allow all surfaces of a building to function as a giant solar panel, and batteries that store solar-produced electricity overnight or even for days.

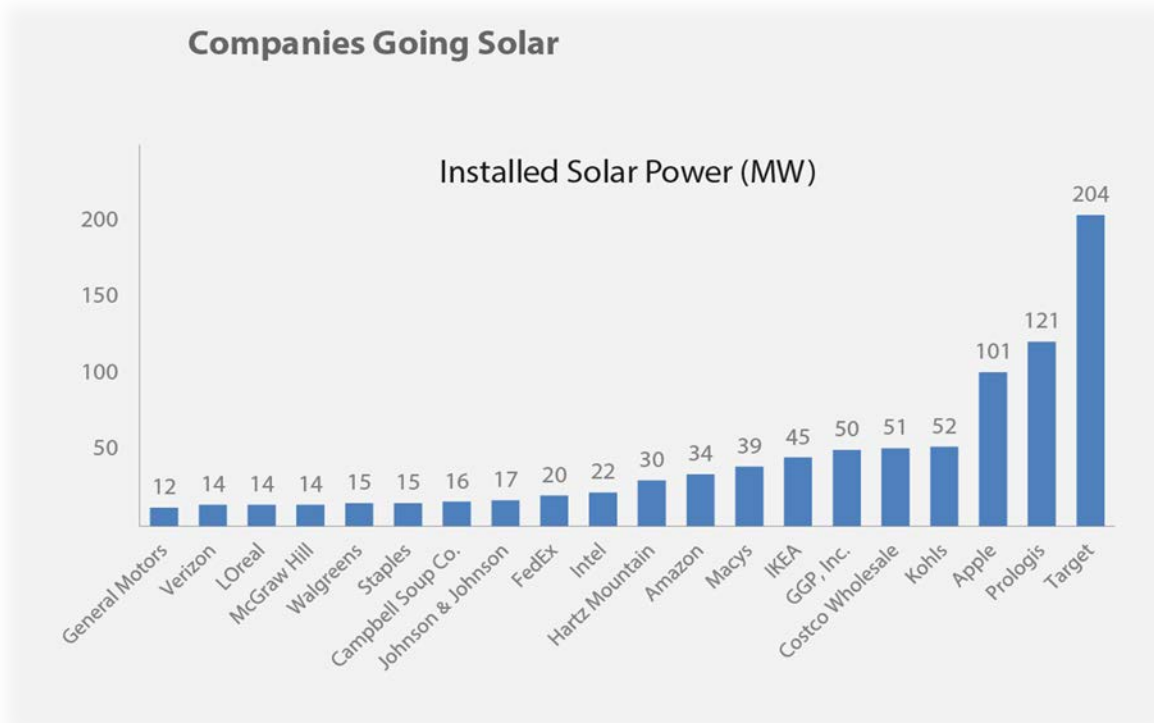

As production prices dip lower and lower, arguments for solar energy production shift from economics to eco-friendliness. Many experts believe that the global economy will



soon reach a point where solar energy is the preferred source of electricity even if the costs are slightly higher than conventional generation methods.

## Working of a solar panel

If my audience was a group of people who were not very well versed with scientific terms and weren't interested in finding out either, I would say the photons or particles of sunlight knock out electrons from the atoms and create a flow of electricity in the circuit, but clearly that is not the case.

A solar panel consists of a layer of silicon cells, a metal frame, a glass casing with a special film and, wiring. Now if multiple cells are grouped in an ordered series it forms a *Solar Array*.



The figure shows a Solar Array. A single unit among this array will be called as a solar panel. Usually, the term array is used to describe a large scale solar farm but technically, any grouping of solar panels is a Solar Array. This whole grouping works together as a system.

# What are Solar Cells made of?

Solar cells are made from *Silicon* or *Germanium*. Both are chemical elements, they are called as semi-conductors. Both of them have 4 electrons in their outer shell. Upon application of energy i.e in the form of photons or heat, the electrons leave their outer shell. These electrons are then called as free electrons.

A solar panel is made by joining 6"x6" cells of silicon with metal contacts on the face and covering it with glass and placing it on a protective back sheet. Panels usually come in 60 and 72 cells configuration.

Multiple panels are connected to power a building or a house. Panels connected to the same inverter as called as a string of panels.

## A solar energy system

To generate your energy, you need a solar system. A solar system has some necessary components which cannot be ignored:

- Solar Panels
- Inverter
- Racking

Racking is the stand or a foundation on which you mount your solar panels. They are of prime importance as they play a vital in determining how you will receive an optimal amount of energy throughout the day.

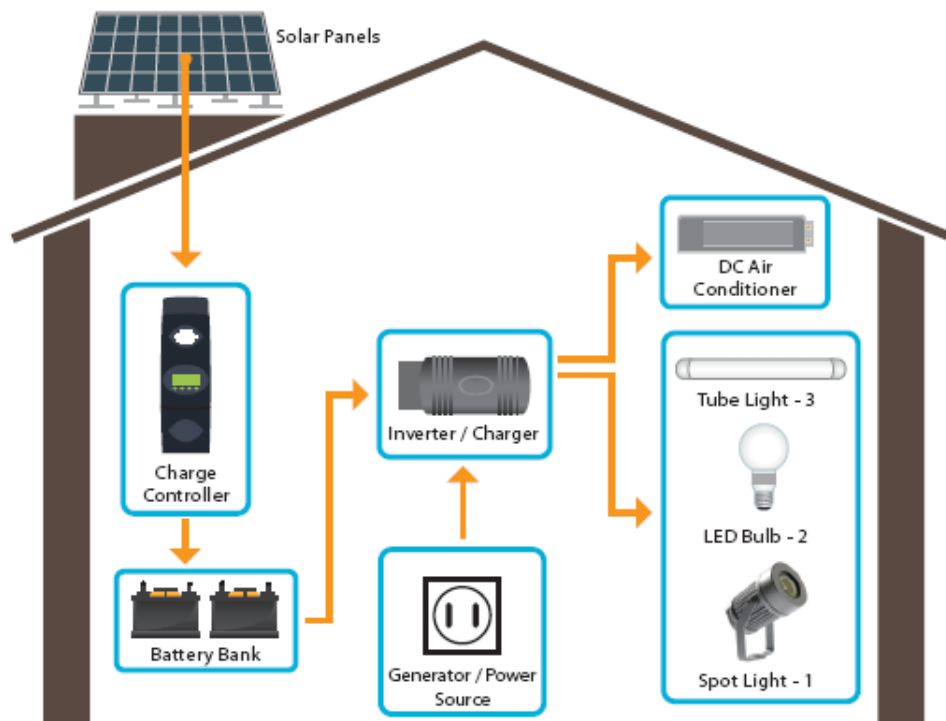

Using these components you can use energy as it is produced. To store the energy you further need some components:

- Charge controller
- Batteries

## Grid-tie and Off-grid Systems

All solar panels work on the same principle. The sunlight falls on PV cells, these cells release electrons, which produce a current in the circuit. The Solar systems are categorized into 3 types:

1. *On-Grid systems* also known as Grid-tie or grid feed systems
2. *Off-Grid systems* also known as stand-alone power systems (SAPS)
3. *Hybrid systems* in which solar power is used with battery storage and grid connection

The most commonly used solar systems by homes and businesses are Grid-tie or On-grid solar systems. These systems do not need batteries and use simple inverters and are further connected to the grid. The electricity is generated continuously and used simultaneously. The excess amount of energy that remains unused is loaded into the public grid, for doing this user gets paid in tariff or gets credit which can be redeemed at a later point.

**On-grid systems** cannot generate or use electricity during a blackout. Since blackouts occur due to damage or fault on the public grid hence they cannot produce electricity otherwise the energy produced would get loaded onto the public grid and harm the workers working maintenance on the grid.

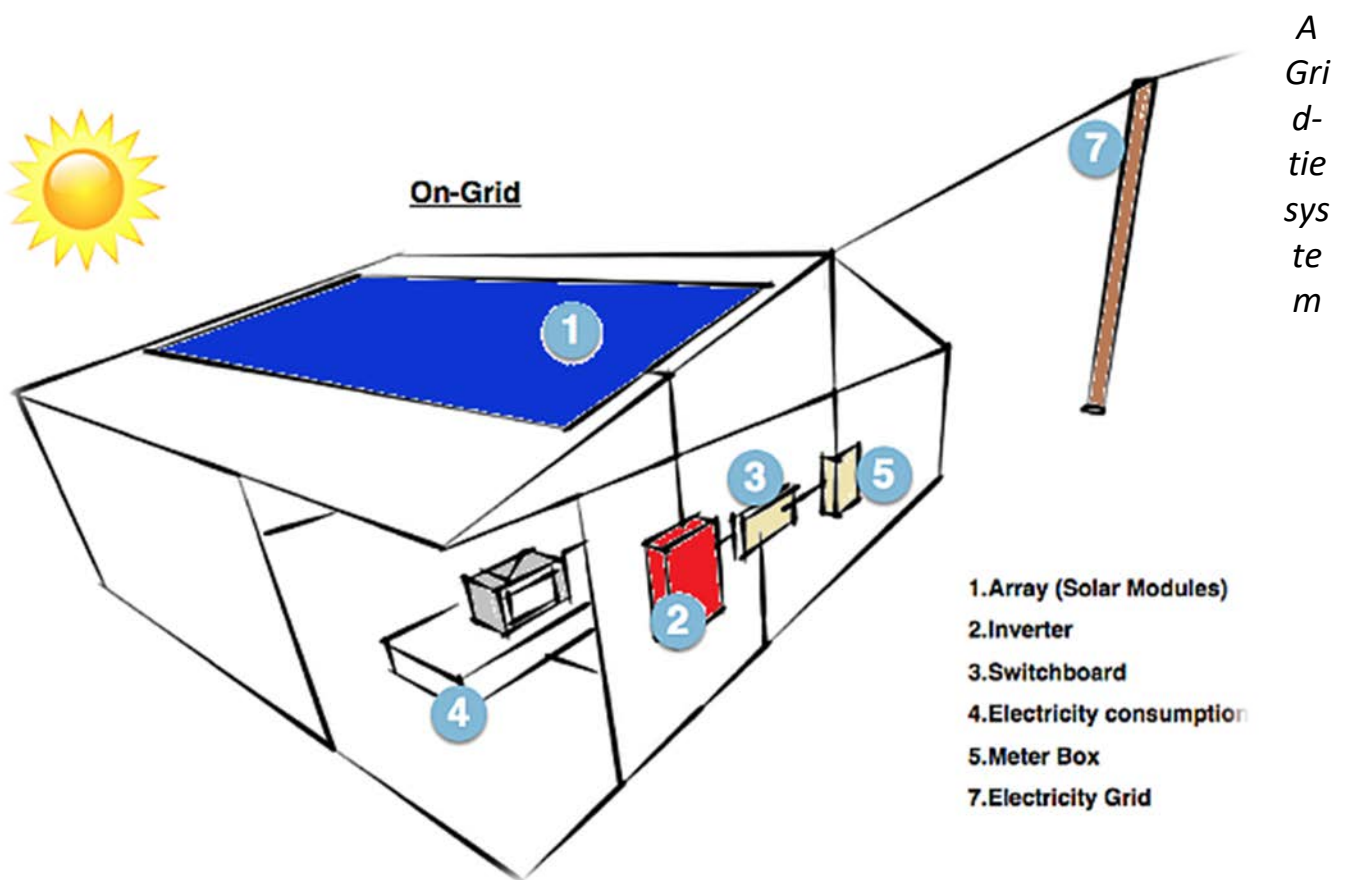

**An off-grid system** uses batteries since it is not connected to any grid (as the name suggests). When designing an off-grid solar system, you need to keep in view the requirements of the house. Fulfilling the requirements of the house isn't enough - the system should also be able to feed the storage so when the night comes there is enough energy them to be utilized.

The best way is to use batteries and off-grid inverters. In technical terms, it is basically an AC coupled system in a DC-coupled system. The power is first sent to the batteries from there it is sent to your appliances.

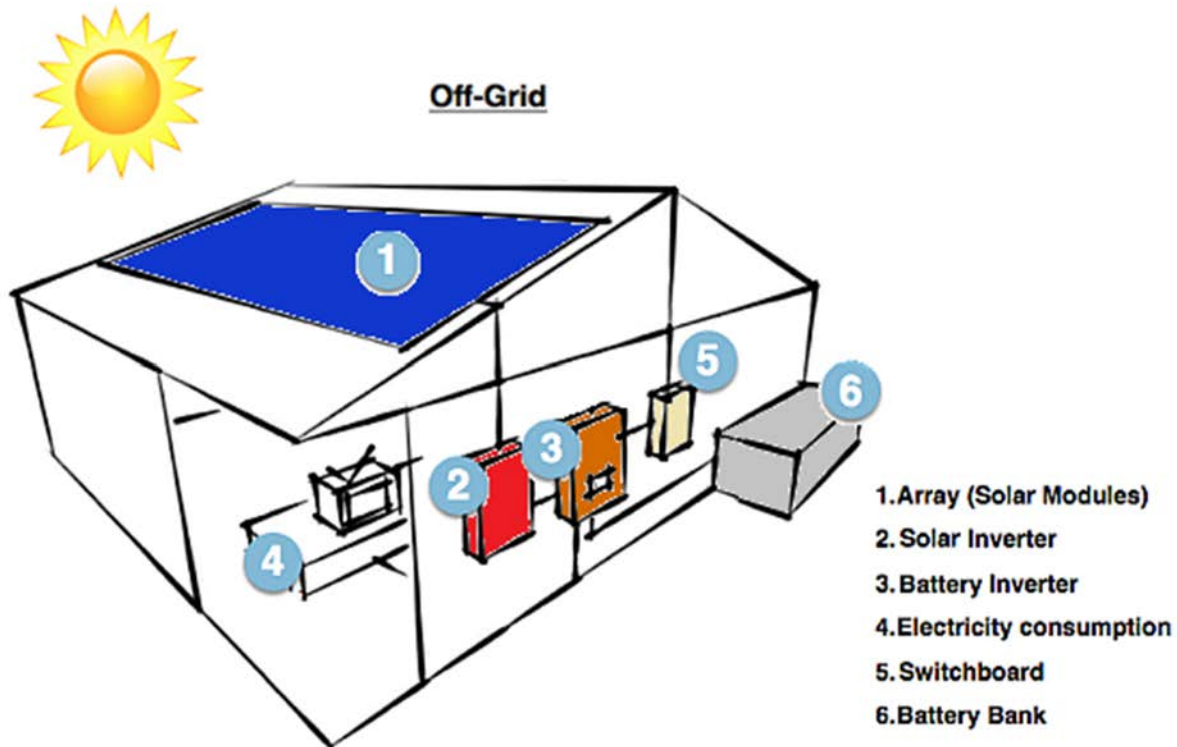

*The figure shows an Off-Grid system*

**Hybrid systems** combine solar and battery storage into one. They are available in different forms and configurations. Due to the decreasing cost of battery storage, systems that are already connected to the electricity grid can start taking advantage of battery storage as well. This means being able to store solar energy that is generated during the day and using it at night. When the stored energy is depleted, the grid is there as a backup, allowing consumers to have the best of both worlds. Hybrid systems are also able to charge the batteries using cheap off-peak electricity (usually after midnight to 6 am).



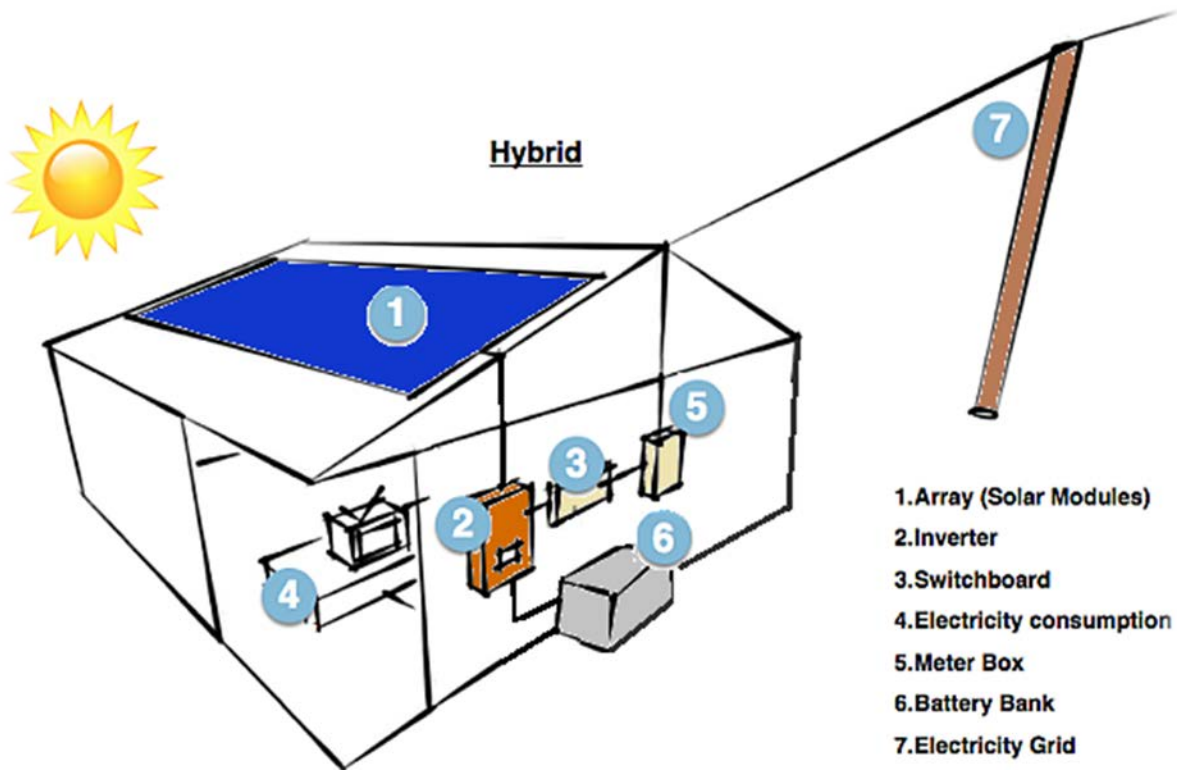

*The figure shows a Hybrid solar system*

All of these systems are used for domestic and commercial purposes. Each of them has their abilities and tradeoffs. The Grid-tie systems are inexpensive as compared to other systems but they aren't as efficient as hybrid and off-grid systems. Hybrid systems, on the other hand, are extremely efficient but they are also expensive. Off-grid systems are average in terms of efficiency and money consumption. All of these systems have different types of inverters.

# How to place Solar Arrays

Sunlight hits the panels in the form of an array. The system is connected to inverters. When the sunlight hits the panels it generates *Direct Current (DC)* in the circuit. Keeping in view that sunlight is solely responsible to generate electricity, how the Solar Arrays are positioned is very important.

Naturally, if you're in the northern hemisphere, placing your array southward will help you receive more sunlight and in turn, you will get more electricity. You get the maximum efficiency when the sunlight is perpendicular to the solar array, for this purpose some farms use solar tracking systems which help the arrays stay perpendicular to the sun at all times. Since this setup is expensive, people generally choose an optimal position for their arrays. This optimal position is the one that receives the most sunlight throughout the day.

The tilt of the Solar Array also called angle is very important. The angle at which it must be set to give maximum efficiency is determined by geographical latitude. A general rule to obtain maximum efficiency from the system is to set it at the angle of the *Geographical Latitude* of the place. Say, a solar park is located near the northern pole, to obtain maximum energy from it, the arrays should be facing the equator and vice versa for the southern pole. For a solar park situated at the equator, the arrays should be pointing straight upward for maximum energy production.

The following diagram shows the optimal angles of installation throughout different locations in the world.

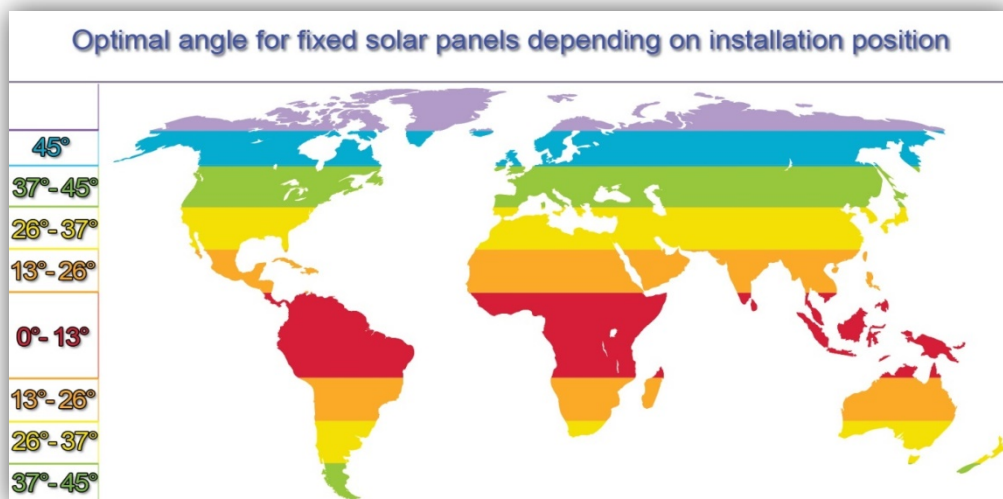

## Other sources of energy

### Wind Energy

This is one of the energy sources that have been in use for a very long time and for centuries. It was used in powering sailing ships, which made it possible for explorers to sail around their trade routes in distant lands. A single windmill can power the crop irrigation, and the family energy needs, water pumping and electric lights. However, in the present time there are several windmills that are used to generate required energy mostly for industrial uses. Many of the wind turbines can capture much power all at once before feeding it to the power grid. This is commonly known as wind farms and has been in use for many years all round the world. It is only the United States that is going slow in terms of accepting this alternative energy source.



Wind power is a renewable source of energy and reduces our reliance on foreign countries for supply of oil and gas. It does not cause any air pollution and has created several jobs in the last few decades. Advancement in technologies has brought down the cost of setting up a wind power plant. Wind energy can only be used in areas which experience high winds, which means that it cannot be used as a source to extract energy anywhere on earth. They sometimes create noise disturbances and cannot be used near residential areas. These disadvantages have made the use of wind energy to particular regions only.

## Geothermal Energy

'Geo' means Earth and 'thermal' means energy. Geothermal energy means energy drawn or harnessed from beneath the earth. It is completely clean and renewable. Geothermal energy has been in use since last several years. The earth contains a molten rock called magma. Heat is continuously produced from there. The temperature increases about 3 degrees Celsius, for every 100 meters you go below ground. Below, 10,000 meters the temperature is so high, that it can be used to boil water. Water makes its way deep inside the earth and hot rock boils that water. The boiling water then produces steam which is captured by geothermal heat pumps. The steam turns the turbines which in turn activates generators.



Geothermal energy can be found anywhere on the earth. Most countries tap this energy to generate electricity, using thermal mass flowmeters, and power millions of homes. The areas which have high underground temperatures are the ones which are prone to earthquakes and volcanoes. The United States produces more Geothermal electricity than any other country in the world. Most hot water geothermal reservoirs are located in the western states, Alaska, and Hawaii. Geothermal energy is totally renewable as earth will continue to produce heat as long as we are all here. If these resources are tapped and are utilized effectively, they can provide solution to the world's power problems.

Geothermal energy produces no pollution, reduces our reliance on fossil fuels. It also results in significant cost savings as no fuel is required to harness energy from beneath the earth. These advantages make geothermal energy as one of the best alternative energy sources.





But, geothermal has its downsides too. It is suitable to particular region and cannot be harnessed everywhere. The earth may release some harmful gases while releasing the heat which may prove adverse from mankind. Also, the areas where this energy is harnessed are prone to earthquakes and volcanoes. Apart from that, setting up of geothermal power stations requires huge installation cost. Here are some pros and cons of geothermal energy.

### **Biomass Energy**

This is the process by which an alternative energy is generated through conversion of biological materials and wastes into forms that can be used as energy sources for heating, power generation and transportation. Those carbon based substances or materials converted over a long period of time to fossil fuels are not regarded as biomass. However, in their original state they are regarded as biomass. This is because of the separation of the carbon they previously contained from the carbon cycle. This makes them figure differently affecting carbon dioxide levels in air.



Biomass energy has been around since ancient times when people use to burn wood or coal to heat their homes or prepare food. Wood still remains the most common source to produce biomass energy. Apart from wood, the other products that are used to create biomass energy include crops, plants, landfills, municipal and industrial waste, trees and agricultural waste.



## Biomass to Electricity

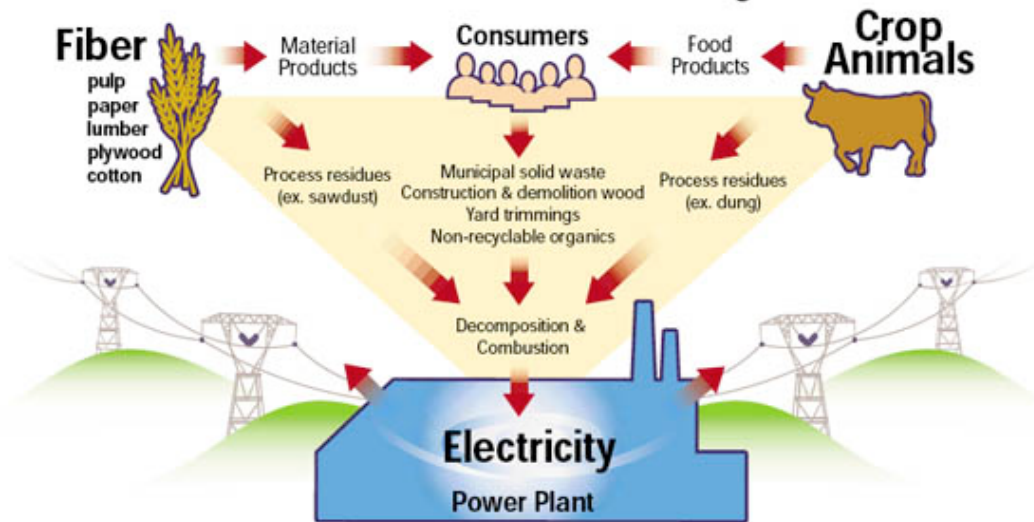

Biomass is renewable source of energy as we would be able to produce it as long as crops, plants and waste exist. It does not create any greenhouse gases and is can be easily extracted through the process of combustion.

Another advantage of biomass is that it helps to reduce landfills. Biomass is comparatively ineffective as compared to fossil fuels. They release methane gases which can be harmful to the environment. Read more about the advantages and disadvantages of biomass here.



## Ocean Energy

The earth promises many power sources. Just like the geothermal and solar energy, which have long been used in heating homes and lighting as well when harnessed. Even in the last century these forms of energy was in use. Due to massive size of oceans, this energy can be used on much wider scale than other alternative sources of energy. The waves produced by the



ocean and tides that hit the sea shore has enormous potential in them. If they are harnessed with full capacity they can go a long way in reducing world's energy problems. There are 3 ways i.e. Tidal energy, Wave energy and Ocean thermal energy conversion (OTEC) via which ocean energy can be harnessed.

Tidal power basically involves using kinetic energy from the incoming and outgoing tides. The difference in high tides and low tides are also important in this respect. There is a lot of energy that can be harnessed from waves for use. It is another form of hydropower. The rise and fall of ocean tides are captured by tidal energy



generators which turn turbines. The movement of turbines is responsible for producing electricity. In short, tidal energy generator captures the kinetic motion of the tides and converts them into electrical energy. The main advantage of tidal energy is that it is completely renewable and are much more predictable than wave energy. Learn more about the tidal energy here.

## Hydrogen Energy

Hydrogen is the most abundant element available on earth but it is rarely alone. Even water contains two third of hydrogen. It is usually available with other elements and have to separated before we can make use of it. Hydrogen has tremendous potential and can be used to power up homes, vehicles and even space rockets. It takes a lot of energy to separate hydrogen from other elements and therefore it proves to quite expensive to extract it. Take a close look at hydrogen energy and see how it works.

The main benefit of hydrogen energy is that it is clean source of fuel and does not leave any waste elements behind except water. There are no harmful emissions and is environment friendly. It is completely renewable and can be produced over and over again on demand. Hydrogen can also be used to make bombs like the ones used by America on Hiroshima and Nagasaki which makes it highly inflammable. Dependency on fossil fuels still remains as we need them to extract hydrogen from other elements. Also, it is quite expensive to produce and store.

## Hydro Energy

Solar energy is produced by sun and wind energy is produced by moving of winds. The heat caused by sun drives the wind. The movement of winds is then captured by wind turbines. Both wind and sun cause water to evaporate. The water vapor then turns into rain or snow and flows down to sea or oceans through rivers or streams. The energy of the moving water can then be captured and called as hydroelectric power. Hydroelectric power stations capture the kinetic energy of moving water and give mechanical energy to turbines. The moving turbines then convert mechanical energy into electrical energy through generators. Dams around the world have been built for this purpose only. Hydropower is the largest producer of alternative energy in the world.





There are different types of hydropower plants. The selection of hydropower plant depends on many volume and flow of water. Hydropower is renewable, constant, predictable and controllable source of energy. They emit no greenhouse gases and are environment friendly. On the negative side, they may cause adverse effect on aquatic life, reduce flow of water which may affect agriculture, require huge costs to build and may cause havoc if they get breakdown.



These are some of the alternative energy sources that can be taken into consideration when planning your energy production and usage. However, they are either too expensive, too complicated to build, too dangerous to use, or your geographical position does not favour one or more of them.

## The 1<sup>st</sup> part of the project

As said earlier, the solar system contains 5 panels and 8 panes. The setup works to get maximum efficiency out of these 5 panels. A panel is laid down straight, the rest of the panels are mounted around this on an angle of  $45^\circ$  at each side. The voids between the interface of the panels are filled with reflective panes, 4 of them. Now the rest of the 4 reflective panels are mounted on top of the side solar panels making an angle of  $135^\circ$  with the base panel.





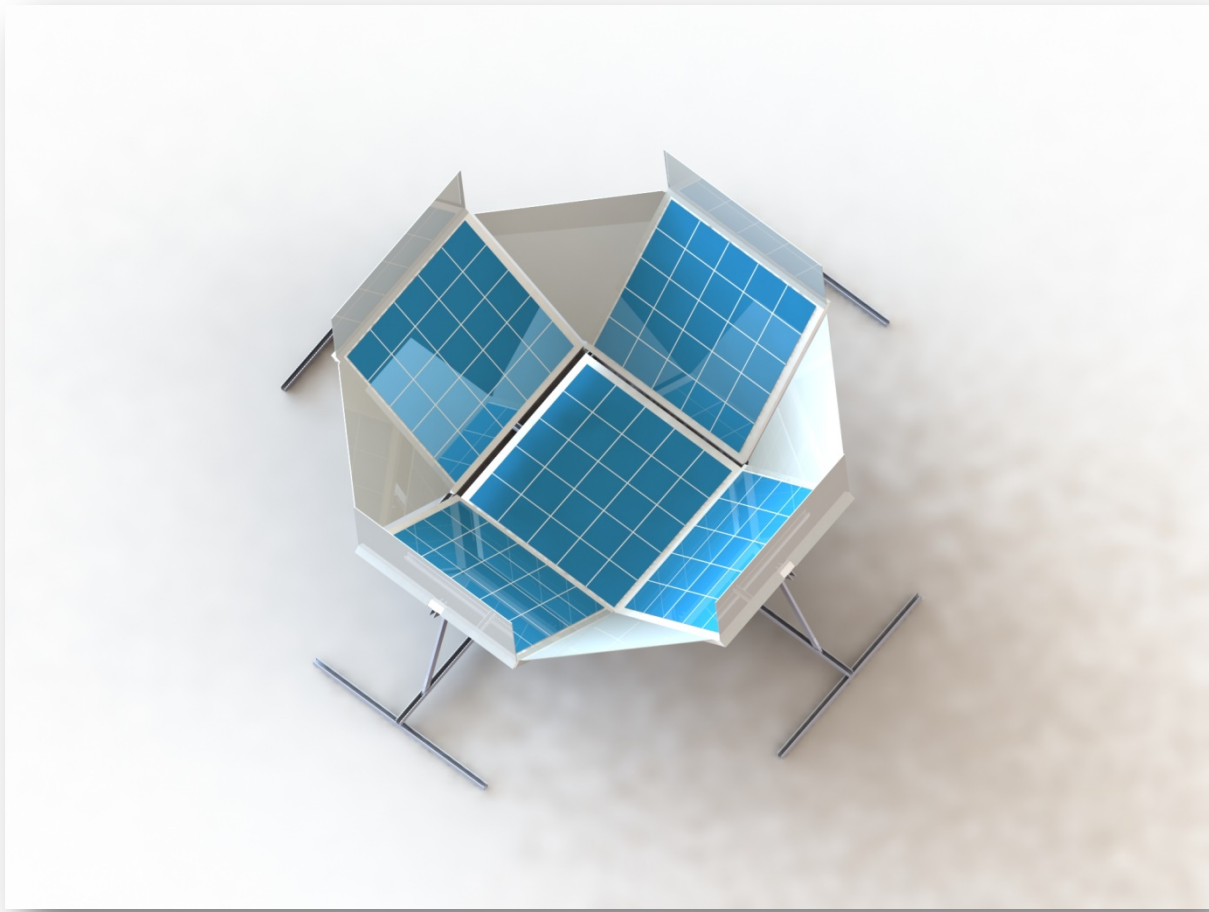

*The figures shows how the final assembly will look like*

The system is designed as such no matter what is the angle of the sun, the sunlight will always fall on one of the five panels, giving it maximum efficiency. You can place it anywhere either on the ground or your rooftop. You also don't have to care for the geographical latitude or the solar tracking system. You will be getting a constant amount of electricity as long as the sun shines and not only. And even when it isn't shining, you can use the reserve power in the batteries. Hence, the solar system has got you covered all round.

# Inverter

The Solar Inverter is an essential device in any solar power system. Its basic function of the inverter is to change the variable Direct Current output of the solar panels into Alternating Current. The converted Alternating Current power is used for running your appliances like the TV, Refrigerator, Microwave, etc. There are 3 main types of inverters:

- a) Off-grid inverter
- b) Grid-tie inverter
- c) Microinverter

**Off-grid inverters** are utilized in remote frameworks wherein the solar inverter is fed DC power from a battery panel. This battery board is charged by solar panels. Several such inverters have interfaced with essential battery chargers which can be utilized to boost the battery from an AC power source.

Another type is the **grid-tie inverter**, these are used to supply the power from the batteries to the grid. They match the phase and frequency of the power in the main grid with the power generated with the help of solar panels and they load it onto the grid.

The main purpose of the inverter is to convert a positive cycle sine wave to a full cycle sine wave. For this purpose, a PWM inverter IC MOSFET is used and setup voltage is provided by a transformer.

These inverters can work directly with the power coming from the solar panels or they can also be used with batteries, depending upon the conditions. Some intelligent systems use high-end inverters which automatically switch between solar energy power and batteries.

There's a maximum number of panels an inverter can support. They have an upper limit, which tells us how many panels can be connected to this inverter. Say, a panel has an upper limit of 20 and a building will need 40 panels to power it perfectly. 2 of such inverters will be used to power the building. And the solar array will have 40 panels connected in a string.



*The picture shows a solar power inverter*

## **Charge Controllers**

A charge controller or charge regulator is a voltage or current regulator that keeps the batteries from overcharging. It regulates the voltage coming from the solar panels going into the batteries. Most 12 volt solar panels put out 16 to 20 volts. So if there is no regulation, the batteries will be damaged due to higher voltage levels. Most batteries need 14 to 15 volts to get fully charged.

Another question that arises is why do 12-volt panels put out 16 to 20 volts. The reason is that the solar panels are designed as such that they will put out 12 volts even under very dim sunlight. Hence, the voltage output is dependent on the intensity of light as well. When the sunlight is good i.e. at peak hours, the solar panels put out 20 volts.

A 12-volt battery is at 12.7 volts at rest and around 14.4 volts when charging. The solar panels are designed to put out 12-volts when they have a very dim reception of light. When the sunlight is good, they usually put out 16 to 20 volts. Moreover, to charge the batteries solar panels have to put out at least 14.4 volts. Hence, under the worst operating conditions, solar panels should put out more than 14.4 volts. The regulator will need to regulate this 16 to 20 volts to the value that battery needs at that time which is usually between 10.8 to 14.4 volts depending upon the state of the battery.

A 12-volt battery is at 12.7 volts at rest and around 14.4 volts when charging. So the solar panel has to put out this much potential difference under the worst-case scenario. The regulator will need to regulate this 16 to 20 volts to the value that battery needs at that time which is usually between 10.8 to 14.4 volts depending upon the state of the battery.

Charge controllers come in all shapes, sizes, and price ranges. They range from 4.5 amps to 80 amps that are controlled by computers. Generally, there are three types:

- Simple one or two-stage controllers. They rely on relays and shunt transistors which control the voltage in one or two steps. They just shorten the connection with the solar panels once the desired level of voltage is reached. Their real claim to fame is their reliability. They do not have a lot of components, hence there are very small wear and tear and electrical components. They are also the cheapest ones around.
- 3 stage or PWM, these are the industry standard nowadays.
- Maximum Power Point Tracking (MPPT). These are the ultimate charge controllers with prices top of the line as well but their efficiencies are around 94 – 98%. They are also an efficient way to save money on large scale systems since they provide 10 to 30% more power to the batteries.



*The picture shows a newer Charge Controller with Digital interface*

Many controllers which fall in average price range come with LEDs and digital meters to show input and output levels. The newer versions and costly ones have digital computer interfaces that help monitor the performance and set the rating to different levels.

Equalizing lead-acid batteries is a process designed to de-sulfate the battery plates by carrying out a controlled overcharge. Battery plates tend to acquire a sulfate coating over time which then hinders the chemical action between the electrolyte and the plate. By equalizing the battery in this controlled overcharge the outer layer of the plate, including the sulfate coating, is blown off, thereby rejuvenating the battery and allowing all the surface area of the plates to interact with the electrolyte. This is one of the most important functions of a charge controller. The controller needs to monitor if one cell of the battery is more depleted than the other one then the controller needs to provide more charge to it.

PWM stands for Pulse Width Modulation. PWM is often used as a method of float charging. Instead of sending a steady pulse to the battery, it sends out a series of short charging pulses.

A *Battery System Monitor* is different from a controller. It monitors the voltage levels and charge levels on each cell but it doesn't perform the regulation process. Although, the charge controllers use a battery system monitor, to sense the voltage levels of the battery during charge and discharge cycles.

## Cables

The common types of wires used are copper and aluminum conductors. Copper has greater conductivity hence it carries more current than aluminum with the same circumference of the conductor. Aluminum is also bent during the installation and its conductivity decreases considerably. But aluminum is cheaper as compared to copper.

The cable can be either solid or stranded. A stranded cable is the one that contains multiple wires of smaller circumference wrapped into a bigger wire. A stranded cable is recommended for larger systems. As it allows flexibility. The current always tends to move outward, if you see a current density diagram of current flow across the cross-sectional surface, you will notice that the current flows outward. Hence, stranded cable is better since it has a more cross-sectional area.

The insulation covering the wire is also important as it helps the wire against heat, moisture, and UV rays. THHN is commonly used in indoor and dry locations. USE-2 and RHW-2 can be used in outdoor and moist locations. These cables are UV resistant as well.





*The cross-sectional view of a stranded cable*

## Batteries

In simple terms, a battery turns chemical energy into electrical energy due to a chemical reaction induced by the application of a voltage across its ends. There are 2 types of batteries: primary and secondary. Batteries that cannot be recharged are called primary batteries like dry cells. On the other hand, batteries that can be recharged are called secondary batteries like Lithium-Ion cells.

## How to Assemble

Firstly you need to gather all components: solar panels, reflective aluminum panels, stands, hinges, cables and screws.



Following is a step by step approach to set up the system:

1. Layout one panel on the back. This will be your base panel.
2. Mount the base panel on it.
3. Take 4 hinges of 45° from the kit and fix them on each side of the base panels with screws. There will be 4 interstices on each of the solar for the hinges to fit in.

4. After the hinges are fitted on the base panel, fix one solar panel on each side with the help of screws. After this, all the solar panels will be fixed.
5. Next, we need to fix the aluminum panels that will reflect the stray arrays into one of the panels.
6. Take 8 hinges of 45° and fit them onto all the panels on their horizontal sides.
7. Take 4 triangular reflective panels. Fit each one of them between 2 hinges with screws.
8. Take 5 hinges and screw them on top of all 4 panels.
9. Take 4 reflective panels from the kit and mount them on top of the panels with screws.
10. Place the whole system on the stands panels for extra support.

The setup of solar system is complete at this point. Make sure you tighten the screw nicely. The materials used for the system can resist natural wear and tear.

Next, you need to connect this setup with the inverter, batteries, and the main supply of the house.

1. Connect all the 5 solar panels in series with one another using cables.
2. Plug the other end of the cable into the input port of the charge collector.
3. Take the cable from the output port of your charge collector and plug it into the inverter and the batteries (which are connected parallelly).
4. From the output port of the inverter, take the cables and plug them into your AC household main supply.

Once all these steps are completed, you are good to go. Now you have inexpensive, clean, and renewable energy around the clock 24/7.

## Placement of hinges

You will be needing 2 types of hinges to work with this system:

1. 45°
2. Adjustable hinges

The 45° hinges are to be fixed at all the four sides of the base panel. And also for the horizontal sides of the 4 side panels.

Whereas the 90° hinges are used only to mount the top reflective panels.



*A hinge at 90°*



*An adjustable hinge*

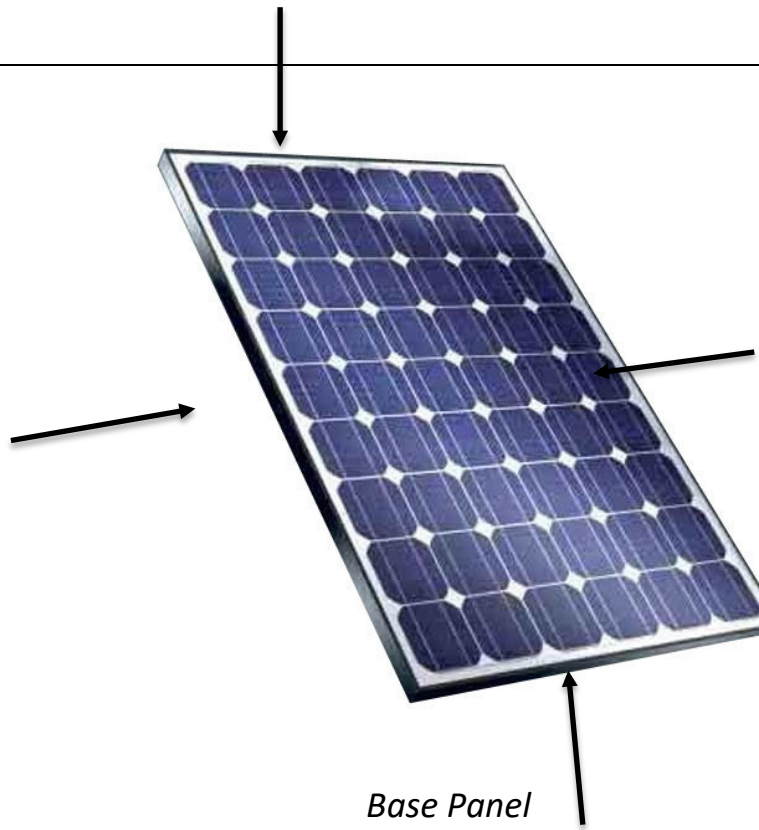

*The above figure shows the base panel and the arrows indicate where the 45° hinges will be placed.*

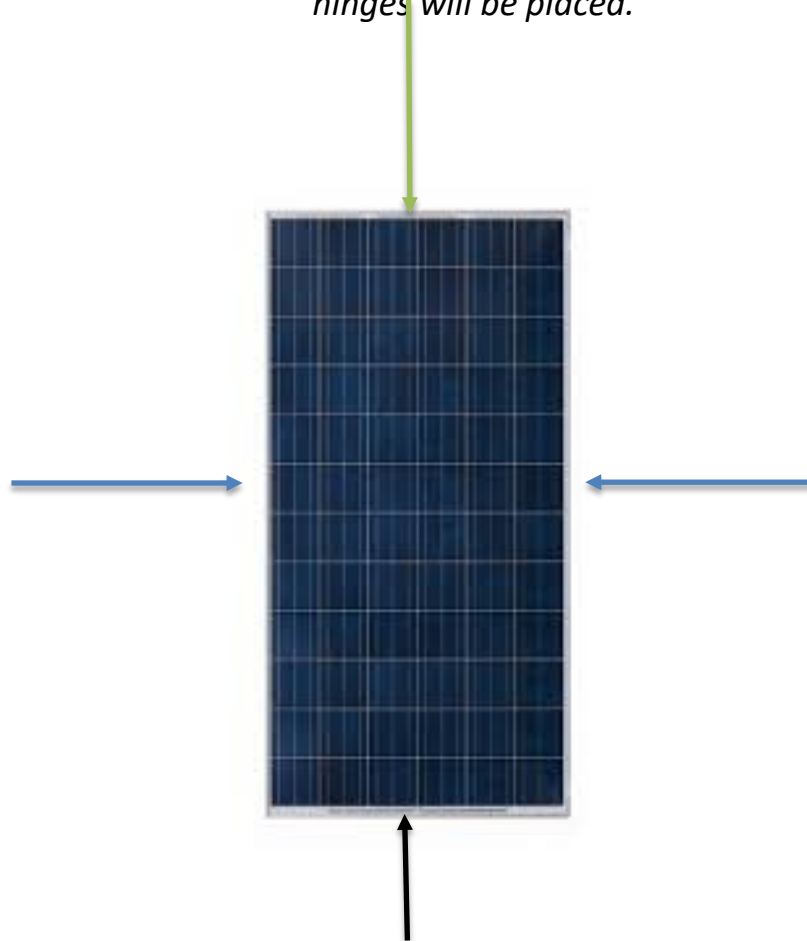

*One of the side panels (can be square)*

In the above-shown figure, there are 3 types of arrows and each one of them represents something different:

- The black arrow shows where the 45° hinge with the base panel will be connected.
- The blue arrows show where 45° hinges will be connected to fit in the triangular reflective panels.
- The green arrow shows where the adjustable hinge will be connected to fix the top reflective panel.

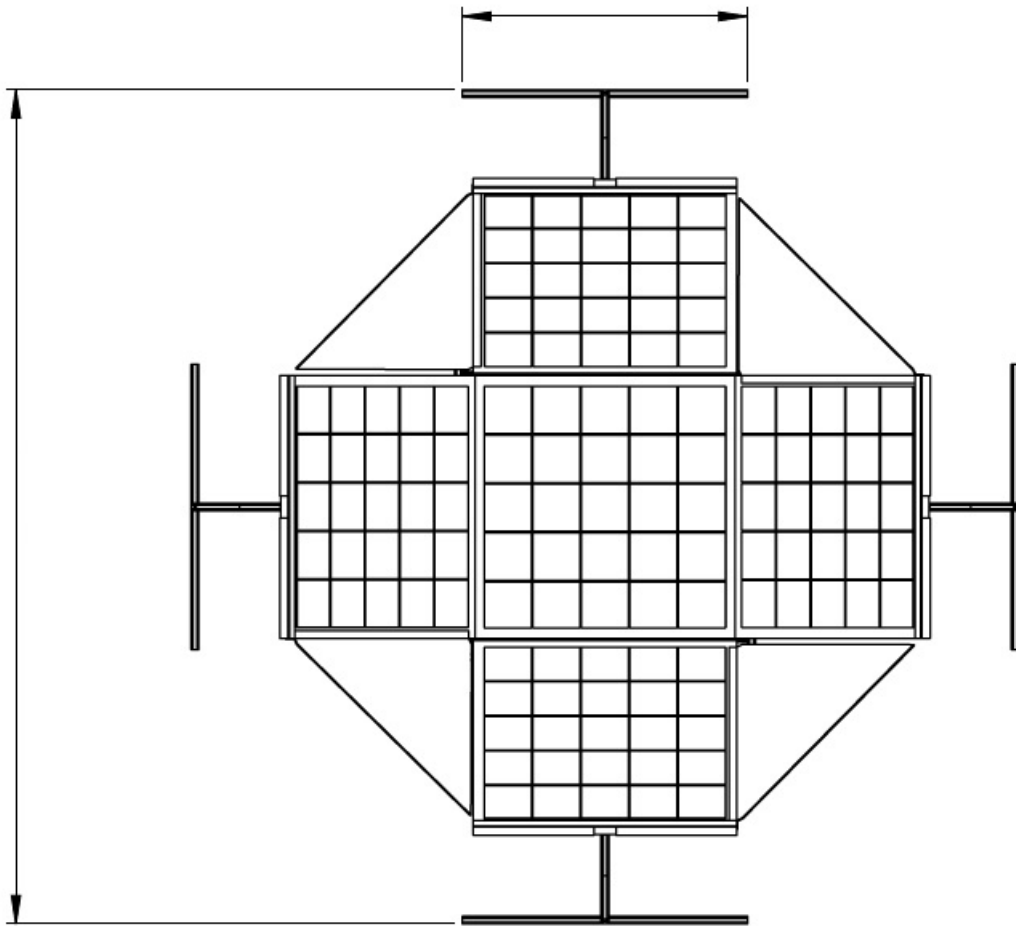

*The above figure shows how the solar system will look from the top once completed*



# Stand

The stand can also be designed in such a way that it is easy to erect. Build the stand however you please, but keep in mind it has to be steady and strong. The different components of the stand are very easy to connect.

Components you will be needing to build one type of stand:

1. Flathead circular rough surface x5
2. 450 units long rods x4
3. 150 units long rods x4
4. A base rod of your own choice, since it will be placed under the base panel to support your whole system. It will be the center of gravity and center of mass so it is suggested it is as close to the ground as possible. This way your center of gravity stays as low as possible and the whole system becomes stable against harsh weather.

Now moving on to how to assemble all this:

1. Join 450 units long and 150 units long rods together, perpendicularly.



The assembly will look as depicted above. You need to make 4 pairs of these.

2. Layout these rods at the ground with a  $90^\circ$  difference between each pair, just like 4 quadrants on the XY plane.

This is how the assembly will look.

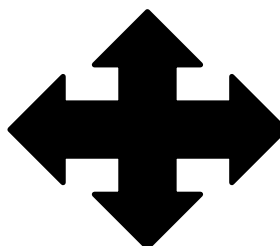

3. Next, join the center smaller rod in the middle of the current assembly.
4. After this is done place the flatheads on each of the ends.
5. Your stand is ready and the system can be mounted on it now.

## Purpose of the Reflective Aluminum Panels

The aluminum panels are the main agent in increasing the efficiency of the whole solar system. They do not let any of the sunlight entering the dish go to waste or astray. They reflect it to one of the five solar panels in the system. No matter how crooked is the angle of the sunlight entering into the system, the reflective panels find a way to direct it to the solar panel.

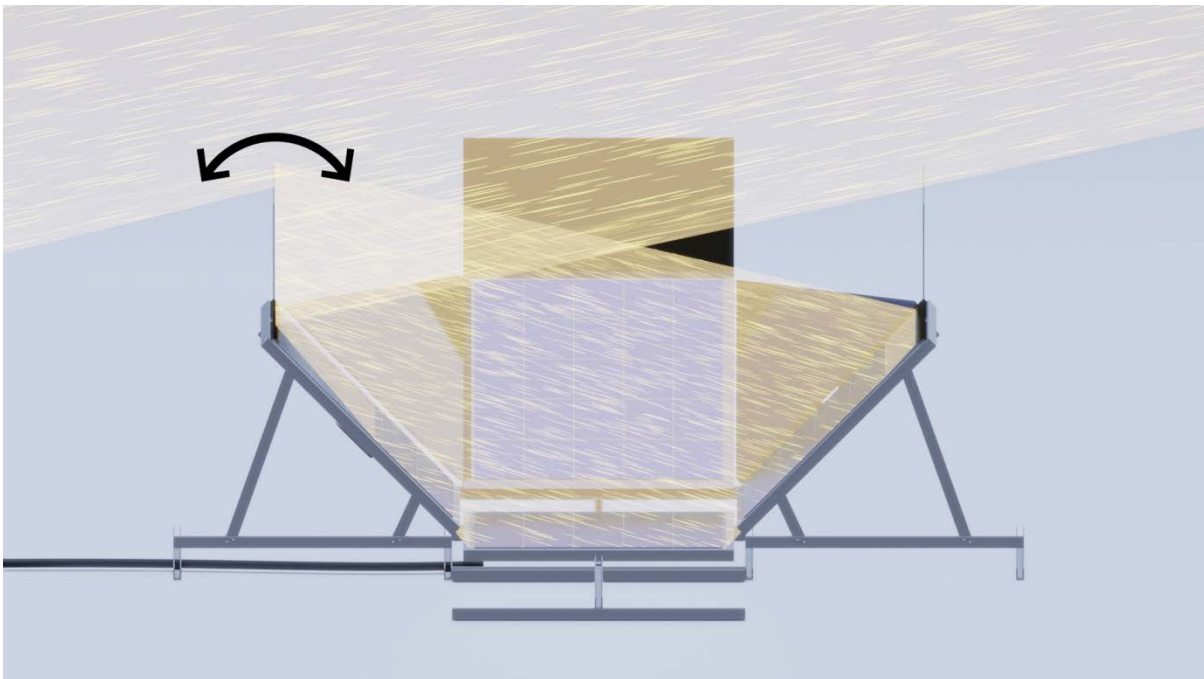

Say sunlight hits the top panel at the angle greater than  $90^\circ$ . It will be reflected, either towards the base panel or the tilted panel opposite to it. Similarly, a ray hits the triangular reflective panel and it will be reflected towards the opposite titled solar panel. In this way, you will be getting the maximum juice out of these five solar panels.

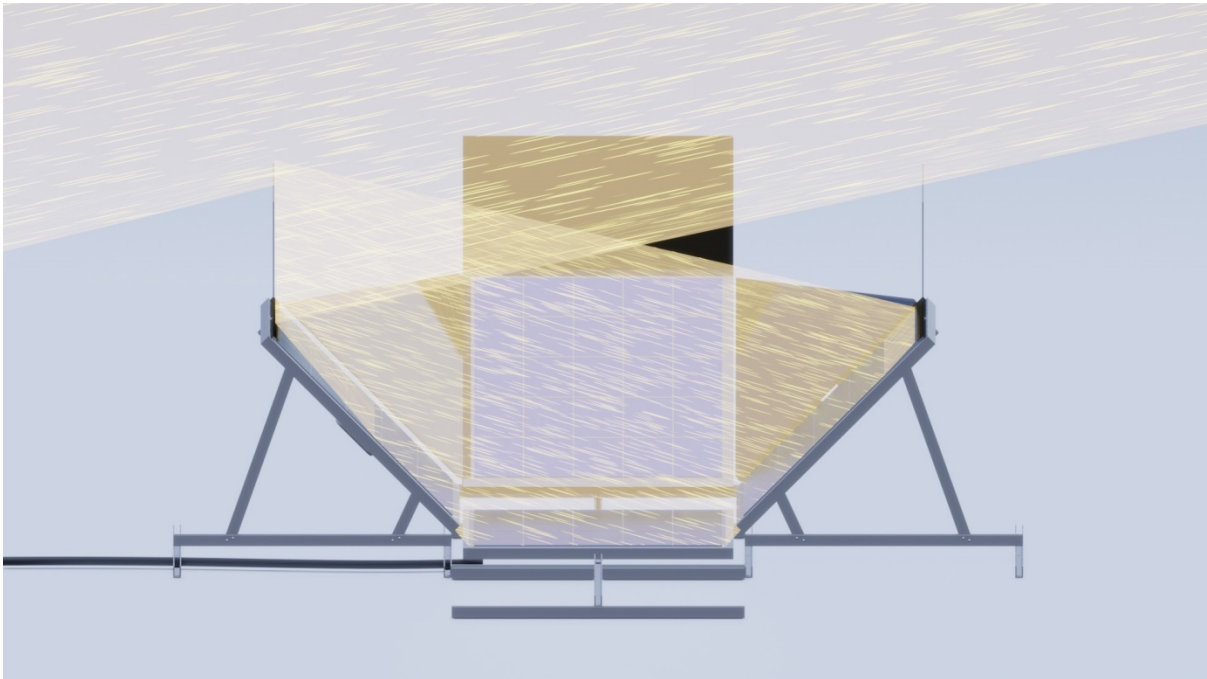
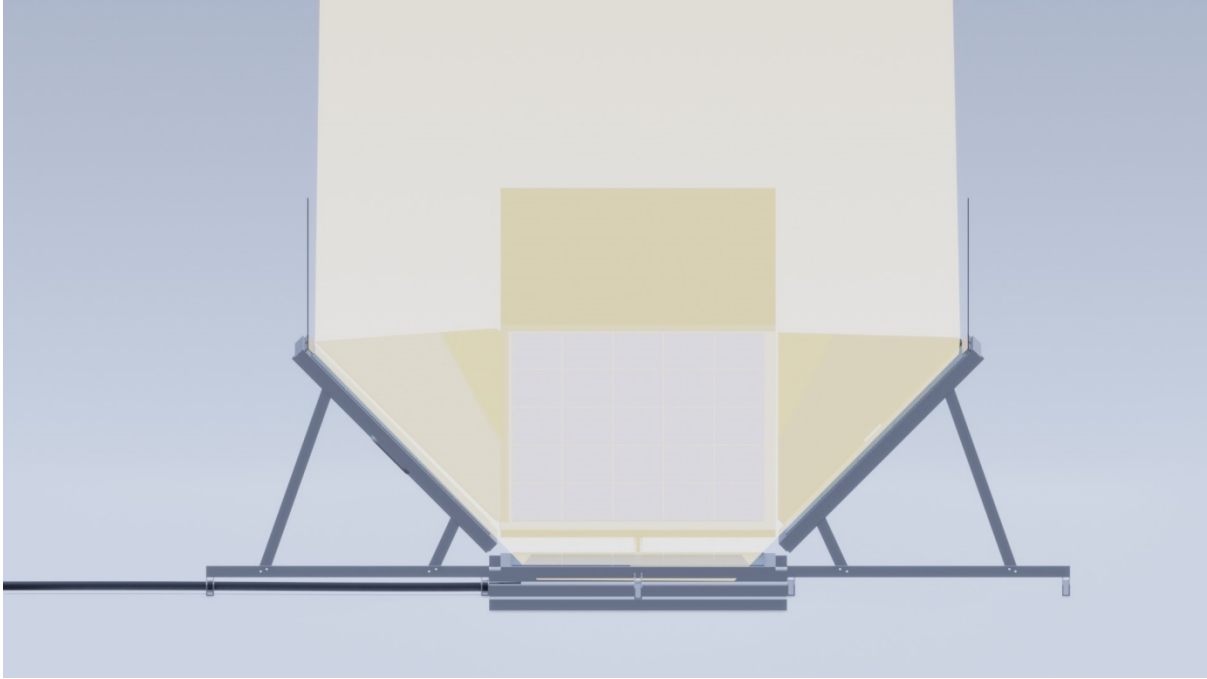

## Portability

The adhesive pieces in the whole system are hinges. Hinges work on the principle of radial movement. This great ability of the hinges allows our system to be folded and be moved from location to another. Once it is folded the system becomes so small that it can be placed in the trunk of your car and can be taken along on one of your trips or picnics. It can also be mounted on top of your RV.

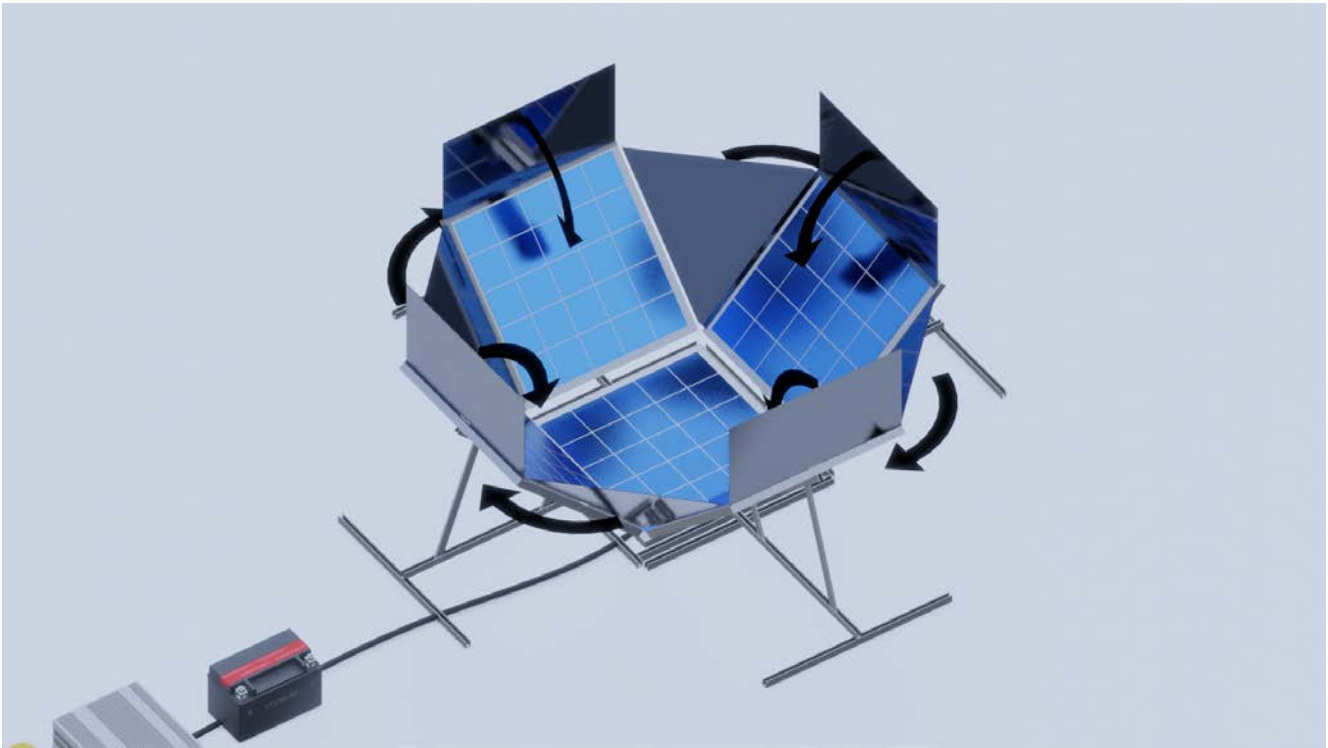

*The figure shows how the system can be folded*

- The rectangular top reflective panels are folded onto the side solar panels.
- Then, the triangular panels are folded and placed on the top of the base solar panel.
- At last, the side panels are folded and they go at the backside of the base solar panel.

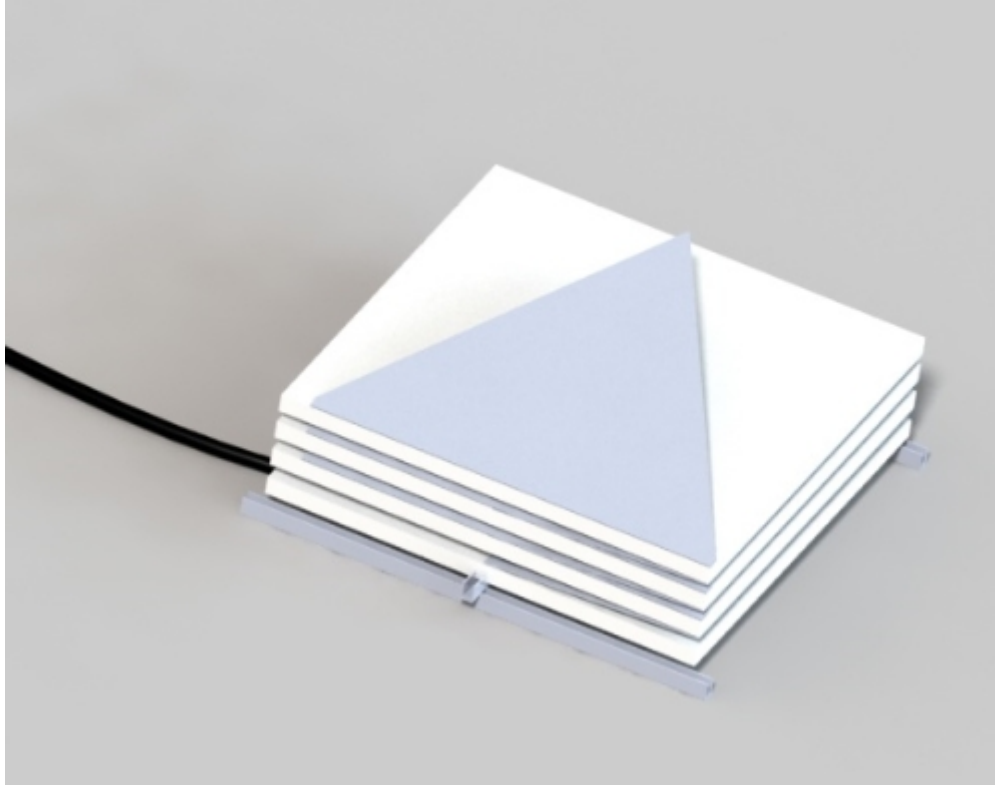

*The picture shows the system folded*

Once the solar system is set up, you can easily connect it to the generator and, due to its design it will constantly spin the rotor and supply energy to power any appliance.

Once the project is complete, you can either go with powering your home directly, powering a battery bank, or using our system that will be presented.



# How to Make a DIY Battery Bank for Your Solar Panels



No matter if it's an off-grid mountain cabin or a battery back-up for your grid-connected homes, the basic process for planning designing your own DIY battery bank is fairly straightforward, but can be a bit confusing your first time around.

Below are the basic steps to planning and designing your own DIY battery bank to complement your solar installation.

## What kinds of batteries are available?



You could use either lead-acid or lithium ion batteries in your battery bank. Lead-acid batteries are cheaper and more common than lithium ion batteries, but lithium ion batteries have longer lifespans, higher efficiencies, and higher energy density than their lead-acid counterparts.

## What is the difference between a Standby battery and a deep cycle battery?

First, we should talk about the application of battery. Generally speaking, there are two major application of industrial battery: standby use and cycle use.

- **Standby use** – emergency power backup for UPS, telecom base station, and security systems. Battery is always fully charged and in standby condition as a power backup, the battery is used only when grid power failure, the battery power supply AC loads via DC-AC inverter during blackouts.

This kind of battery is being used, technically called “discharged”, only several times a year; most of time they are just waiting and standby. When the battery is being used as a power backup, it will not generally get deeply discharged. People focus on its “standby life” than “cycle life”.



- **Deep Cycle use** – power source for e-scooter, e-mobility, e-bike and renewable energy.

The battery is always being used every day as a power source. We call it “one cycle” when battery being fully charged and deeply discharged once.

This kind of battery as a power source is expected to provide as much power as possible to extend the usage time, so it usually gets deeply discharged to provide more power. People focus on its “cycle life” rather than on its “standby life”. These batteries are designed for deep cycle applications are called deep cycle batteries.



## **Why should we use deep cycle battery for solar power system?**

Obviously, battery in a solar power system is being charged in daytime by sun and discharged in cloudy day or night. The battery is acting as a solar energy storage device; it reserves solar power in sunny time and provides power in overcast time or night. So the solar battery is always being fully charged and deeply discharged. We should choose deep cycle batteries for battery banks for solar power system.

## Calculate Your Load



The next step in designing your DIY battery bank is calculating how much electricity you typically use - known as your electricity load. There are two methods to calculate your load:

- First, you can look at your previous electricity usage. If you are already connected to the grid, simply look at your total electricity use for the last 12 months and divide by 365 to get your daily average.
- If you aren't connected to the grid, you probably don't have any data on your previous energy use. In this case, you'll need to calculate how much electricity you need by adding up the wattage of all the electrical devices in the home and estimating how many hours you'll use them each day.

As you can imagine, this process takes time and there are a lot of numbers to keep track of, so be sure not to rush this step! The size of your entire battery bank will be based on these calculations, so you need to make sure they are as accurate as possible!

### **Amount of Back-up Power and Depth of Discharge**

Batteries allow you to store the electricity your solar installation generates for later use, and after you find your daily electrical load, you need to decide how many days of backup power you want. Most homeowners choose between 1 and 4 days, though this depends on your needs and weather.

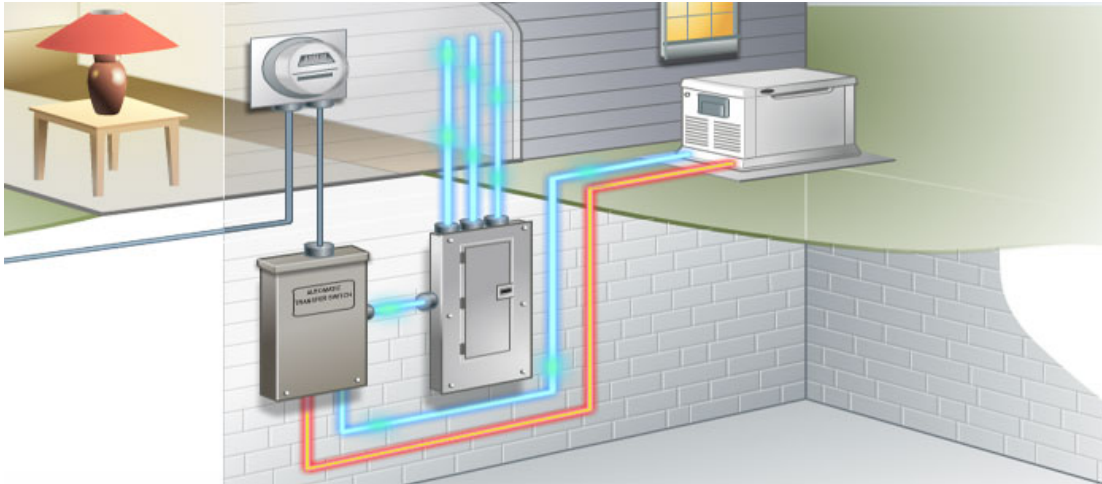

To make the process a little more confusing: battery capacity is measured in amp-hours – not watt-hours or kilowatt-hours like the electricity generated by your solar installation. Lucky for us, finding amp-hours is easy! Simply divide watt-hours by the voltage of the solar installation. Off-grid solar installations can be 12 volt, 24 volt, or 48 volt – the voltage you choose depends on your installation’s size, location and layout, and needs.

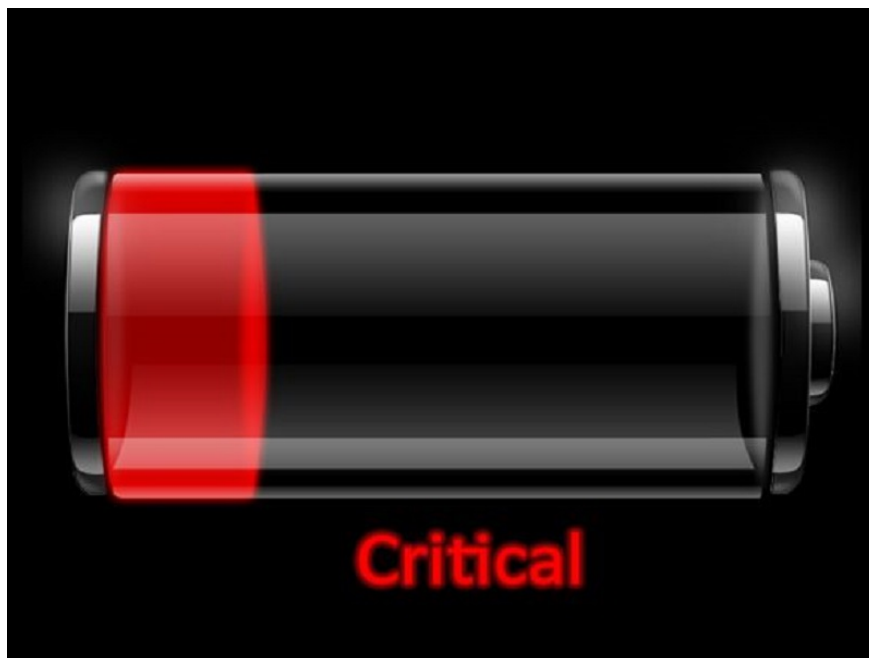

If you discharge the batteries down to their full capacity, you can hinder their ability to fully charge in the future. Because of this, battery manufacturers recommend only using a portion of the available battery, usually only 25% to 50% for lead-acid batteries (the most common type of battery for solar). Of course, only using a small fraction of your batteries’ power is annoying, but just consider all the batteries an



investment. If you only discharge your batteries down to 25% or 50%, they'll provide you with years of reliable service.

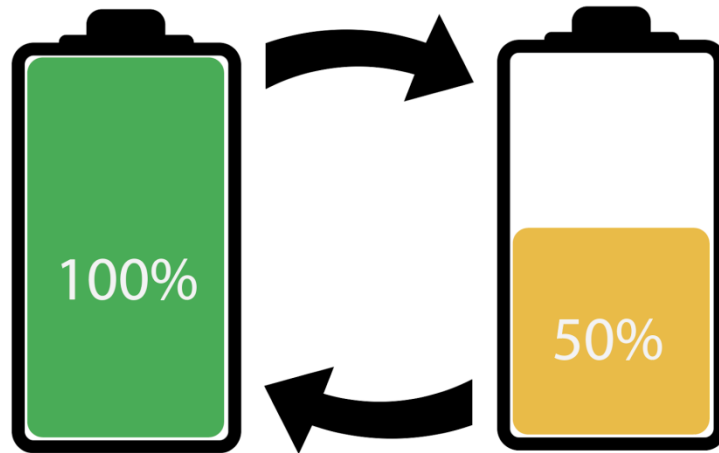

### **Connecting Batteries in Parallel vs in Series**

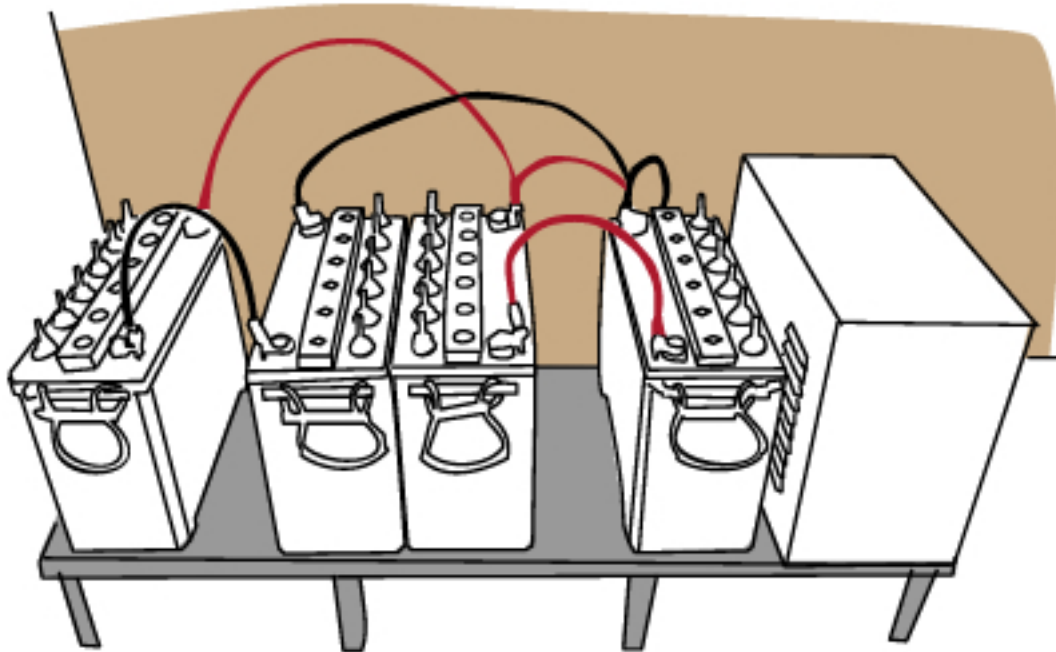

Now that you know the voltage of your installation and the battery capacity you need, it's almost time to start looking at batteries! In your battery system, there are two ways to connect multiple batteries together – in parallel or in series:

- In Parallel: Connecting batteries in parallel simply means that each battery's positive terminal is connected to the next battery's positive terminal (and each negative terminal is connected to the next negative terminal). Batteries that are connected in parallel add up all their amp-hours together, allowing you to increase the total capacity of your battery bank.

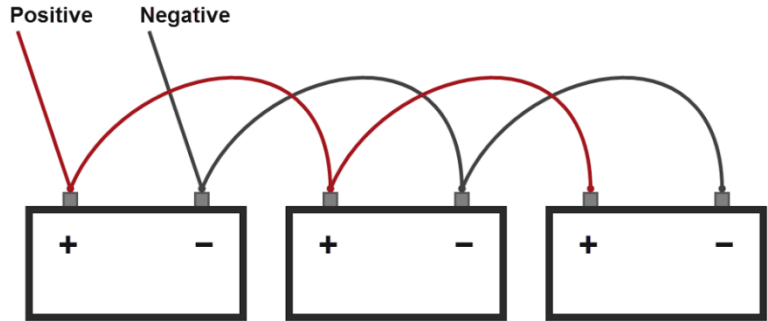

- In Series: Connecting batteries in series means connecting the positive terminal of the first battery to the negative terminal of the next, and so on. When connecting in series, amp-hours don't increase, but voltage adds up amongst all the batteries. It's also possible to create a system where batteries are connected both in parallel and in series to both increase voltage and amp-hours!

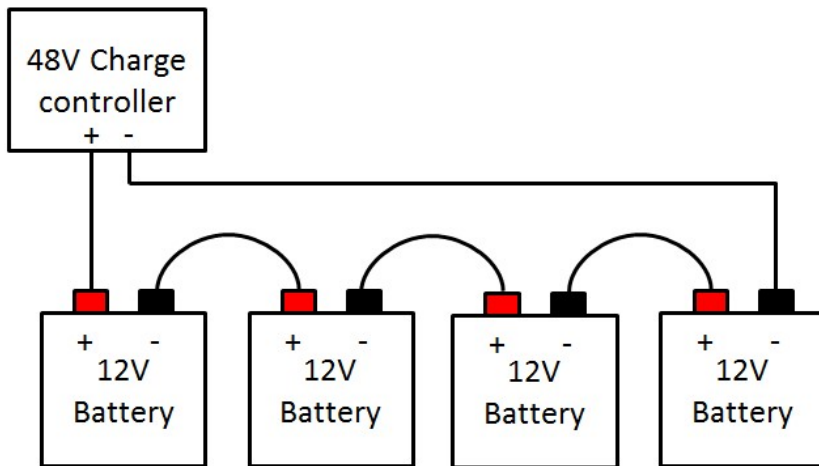

series, amp-hours don't increase, but voltage adds up amongst all the batteries. It's also possible to create a system where batteries are connected both in parallel and in series to both increase voltage and amp-hours!

## The Size of Your Inverter

Although we've covered this part, we want to fully explain the role of the inverter. Inverters are an integral part of any solar and storage installation, as they convert the direct current (DC) electricity produced by your solar panels and housed in the batteries to alternating current (AC) required by all our electronic devices.

Inverters convert electricity from DC to AC in real time. Inverters have no storage capacity – as your devices use electricity, that electricity flows from the batteries through the inverter to the device. Because of this, your inverter needs to be large enough to handle the biggest load you'll put on it at any single instance.

The easiest way to calculate this is to add up the wattage of all your devices that could be operating at the same time.

There's one more critical step though to sizing your inverter. Some electric devices, especially motor-driven devices like refrigerators, power tools, and air conditioners, draw 2 to 8 times the amount of power they typically use just to turn on! This huge power draw is known as the surge load and you need to account for this when choosing an inverter.

Unlike a device's typical wattage, which is printed on the back of a device, manufacturers don't publish the surge load of their devices, so you either need to contact them directly or measure the electrical pull yourself for your motor-driven devices.

Fortunately for us, inverter manufacturers these days account for surge loads and most inverters can handle high spikes of electricity in short bursts. When choosing an inverter, be sure that they can handle the surge load for any of the electrical equipment you use.

## The 2<sup>nd</sup> part of the project

One of the most overlooked solutions to generate energy is magnets. Other sources of energy have been used but, with the inevitable increase in the demand on the world's natural resources, human kind may turn to this unique source of power.

### **What is a Magnet?**

The general definition of a magnet is “An object made of certain materials which create a magnetic field”

However, the word “magnet” was first used by the Greeks as early as 600 B.C. for describing a mysterious stone that attracted iron and other pieces of the same material? According to one Greek legend, the name magnet was taken from the shepherd Magnets who discovered the magnetic stone by accident when his staff was mysteriously attracted to the force of the stone. Another, and perhaps more believable, theory says that the word magnet came from a city in Asia Minor, called Magnesia, where many of these mysterious magnetic stones were found.

During the Middle Ages, this stone became known as lodestone, which is the magnetic form of magnetite. Today, magnets are available in all sorts of shapes including discs, rings, blocks, rectangles, arcs, rods, and bars. They are made out of materials such as ceramic (strontium ferrite), alnico (aluminium, nickel, and cobalt), rare earth (samarium cobalt and neodymium) and flexible, rubber-like material.

### **But what is a magnet?**

A magnet is an object made of certain materials which create a magnetic field.

Magnets are objects that have a north and south pole at opposite ends. A magnet contains electrons that have both uneven orbits and uneven spins. Those magnetic atoms are aligned in nice straight rows inside each domain. And those domains are also lined up all in the same direction. And only with ALL of these conditions satisfied does this piece of metal become a magnet. Don't worry if this doesn't make sense -- we'll break it down over the course of this lesson.

Every magnet has at least one North Pole and one South Pole. By convention, we say that the magnetic field lines leave the north end of a magnet and enter the south end of a magnet. This is an example of a magnetic dipole (“di” means two, thus two poles). If you take a bar magnet and break it into two pieces, each piece will again have a north

pole and a south pole. If you take one of those pieces and break it into two, each of the smaller pieces will have a north pole and a south pole. No matter how small the pieces of the magnet become, each piece will have a north pole and a south pole. It has not been shown to be possible to end up with a single north pole or a single south pole which is a monopole (“mono” means one or single, thus one pole).

All magnets are made of a group of metals called the ferromagnetic metals. These are metals such as nickel and iron. Each of these metals have the special property of being able to be magnetized uniformly. When we ask how a magnet works we are simply asking how the object we call a magnet exerts its magnetic field. The answer is actually quite interesting.

In every material there are several small magnetic fields called domains. Most of the times these domains are independent of each other and face different directions. However, a strong magnetic field can arrange the domains of any ferromagnetic metal so that they align to make a larger and stronger magnetic field. This is how most magnets are made.

The major difference among magnets is whether they are permanent or temporary. Temporary magnets lose their larger magnetic field over time as the domains return to their original positions. The most common way that magnets are produced is by heating them to their Curie temperature or beyond. The Curie temperature is the temperature at which a ferromagnetic metals gains magnetic properties. Heating a ferromagnetic material to its given temperature will make it magnetic for a while. While heating it beyond this point can make the magnetism permanent. Ferromagnetic materials can also be categorized into soft and hard metals. Soft metals lose their magnetic field over time after being magnetized while hard metals are likely candidates for becoming permanent magnets.

Not all magnets are manmade. Some magnets occur naturally in nature such as lodestone. This mineral was used in ancient times to make the first compasses. However, magnets have other uses. With the discovery of the relation between magnetism and electricity, magnets are now a major part of every electric motor and turbine in existence. Magnets have also been used in storing computer data. There is now a type of drive called a solid state drive that allows data to still be saved more efficiently on computers.

Not only do the shape and material of magnets vary, so do their applications. At many companies, magnets are used for lifting, holding, separating, retrieving, sensing,



and material handling. You can find magnets in a car and around your house. Magnets are used in the home to organize tools or kitchen utensils and can be found in doorbells, loudspeakers, microwaves, and televisions. Business offices and schools use magnetic planning boards to display schedules and charts.

Magnets are also used in a compass to guide people if they are lost. In fact, the compass was probably the first important magnetic device discovered. Around the 12th century, someone noticed that when allowed free movement, a magnet always points in the same north/south direction. This discovery helped mariners who often had trouble navigating when the clouds covered the sun or stars.

But the use of the magnets for this device will revolutionize the entire energy industry.

### **What is an electromagnet?**

An electromagnet is a magnet that runs on electricity. Unlike a permanent magnet, the strength of an electromagnet can easily be changed by changing the amount of electric current that flows through it. The poles of an electromagnet can even be reversed by reversing the flow of electricity.

An electromagnet works because an electric current produces a magnetic field. The magnetic field produced by an electric current forms circles around the electric current, as shown in the diagram below:



Mechanically, an electromagnet is pretty simple. It consists of a length of conductive wire, usually copper, wrapped around a piece of metal. A current is introduced, either from a battery or another source of electricity, and flows through the wire. This creates a magnetic field around the coiled wire, magnetizing the metal as if it were a permanent magnet. Electromagnets are useful because you can turn the magnet on and off by completing or interrupting the circuit, respectively.

Before we go too much farther, we should discuss how electromagnets differ from your run-of-the-mill "permanent" magnets. As you know, magnets have two poles, "north" and "south," and attract things made of steel, iron or some combination thereof.

Like poles repel and opposites. For example, if you have two bar magnets with their ends marked "north" and "south," the north end of one magnet will attract the south end of the other. On the other hand, the north end of one magnet will repel the north end of the other (and similarly, south will repel south). An electromagnet is the same way, except it is "temporary" - the magnetic field only exists when electric current is flowing.

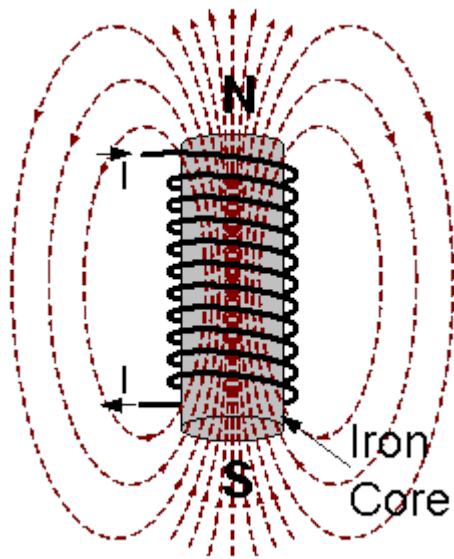

The doorbell is a good example of how electromagnets can be used in applications where permanent magnets just wouldn't make any sense. When a guest pushes the button on your front door, the electronic circuitry inside the door bell closes an electrical loop, meaning the circuit is completed and "turned on." The closed circuit allows electricity to flow, creating a magnetic field and causing the clapper to become magnetized. The hardware of most doorbells consists of a metal bell and metal clapper that, when the magnetic charges cause them to clang together, you hear the chime inside and you can

answer the door. The bell rings, the guest releases the button, the circuit opens and the doorbell stops its infernal ringing. This on-demand magnetism is what makes the electromagnet so useful.

### **Permanent Magnets and Electromagnets: What are the Differences?**

A permanent magnet is an object made from a material that is magnetized and creates its own persistent magnetic field. As the name suggests, a permanent magnet is 'permanent'. This means that it always has a magnetic field and will display a magnetic behavior at all times.

An electromagnet is made from a coil of wire which acts as a magnet when an electric current passes through it. Often an electromagnet is wrapped around a core of ferromagnetic material like steel, which enhances the magnetic field produced by the coil.

### **Permanent Magnet v. Electromagnet: Magnetic Properties**

A permanent magnet's magnetic properties exist when the magnet is (magnetized). An electromagnetic magnet only displays magnetic properties when an electric current is applied to it. That is how you can differentiate between the two. The

magnets that you have affixed to your refrigerator are permanent magnets, while electromagnets are the principle behind AC motors.

### **Permanent Magnet v. Electromagnet: Magnetic Strength**

Permanent magnet strength depends upon the material used in its creation. The strength of an electromagnet can be adjusted by the amount of electric current allowed to flow into it. As a result, the same electromagnet can be adjusted for different strength levels.

### **Permanent Magnet v. Electromagnet: Loss of Magnetic Properties**

If a permanent magnet loses its magnetic properties, as it does by heating to a (maximum) temperature, it will be rendered useless and its magnetic properties can be only recovered by re-magnetizing. Contrarily, an electromagnet loses its magnetic power every time an electric current is removed and becomes magnetic once again when the electric field is introduced.

### **Permanent Magnet v. Electromagnet: Advantages**

The main advantage of a permanent magnet over an electromagnet is that a permanent magnet does not require a continuous supply of electrical energy to maintain its magnetic field. However, an electromagnet's magnetic field can be rapidly manipulated over a wide range by controlling the amount of electric current supplied to the electromagnet.

The Easy DIY Power Plan uses this principles and multiplies the energy the magnets supply, eventually offering enough energy to power household appliances.

### **The most recent and life changing discovery is the Neodymium Magnet**

A neodymium magnet (also known as NdFeB, NIB or Neo magnet), the most widely used type of rare-earth magnet, is a permanent magnet made from an alloy of neodymium, iron and boron to form the  $\text{Nd}_2\text{Fe}_{14}\text{B}$  tetragonal crystalline structure. Developed in 1982 by General Motors and Sumitomo Special Metals, neodymium magnets are the strongest type of permanent magnet commercially available. They have replaced other types of magnets in the many applications in modern products that require strong permanent magnets, such as motors in cordless tools, hard disk drives and magnetic fasteners.

## Description

Neodymium is a metal which is ferromagnetic (more specifically it shows antiferromagnetic properties), meaning that like iron it can be magnetized to become a magnet, but its Curie temperature (the temperature above which its ferromagnetism disappears) is 19 K ( $-254\text{ }^{\circ}\text{C}$ ), so in pure form its magnetism only appears at extremely low temperatures.<sup>[4]</sup> However, compounds of neodymium with transition metals such as iron can have Curie temperatures well above room temperature, and these are used to make neodymium magnets.

The strength of neodymium magnets is due to several factors. The tetragonal  $\text{Nd}_2\text{Fe}_{14}\text{B}$  crystal structure has exceptionally high uniaxial magnetocrystalline anisotropy ( $H_A \sim 7\text{ T}$  – magnetic field strength  $H$  in units of  $\text{A}/\text{m}$  versus magnetic moment in  $\text{A}\cdot\text{m}^2$ ).<sup>[5]</sup> This means a crystal of the material preferentially magnetizes along a specific crystal axis, but is very difficult to magnetize in other directions. Like other magnets, the neodymium magnet alloy is composed of microcrystalline grains which are aligned in a powerful magnetic field during manufacture so their magnetic axes all point in the same direction. The resistance of the crystal lattice to turning its direction of magnetization gives the compound a very high coercivity, or resistance to being demagnetized.

The neodymium atom also can have a large magnetic dipole moment because it has 7 unpaired electrons in its electron structure<sup>[6]</sup> as opposed to (on average) 3 in iron. In a magnet it is the unpaired electrons, aligned so they spin in the same direction, which generate the magnetic field. This gives the  $\text{Nd}_2\text{Fe}_{14}\text{B}$  compound a high saturation magnetization ( $J_s \sim 1.6\text{ T}$  or 16 kG) and typically 1.3 teslas. Therefore, as the maximum energy density is proportional to  $J_s^2$ , this magnetic phase has the potential for storing large amounts of magnetic energy ( $BH_{\text{max}} \sim 512\text{ kJ}/\text{m}^3$  or 64 MG·Oe). This magnetic energy value is about 18 times greater than "ordinary" magnets by volume. This property is higher in NdFeB alloys than in samarium cobalt (SmCo) magnets, which were the first type of rare-earth magnet to be commercialized. In practice, the magnetic properties of neodymium magnets depend on the alloy composition, microstructure, and manufacturing technique employed.

## History

In 1982, General Motors (GM) and Sumitomo Special Metals discovered the  $\text{Nd}_2\text{Fe}_{14}\text{B}$  compound. The research was initially driven by the high raw materials cost of SmCo permanent magnets, which had been developed earlier. GM focused on the development of melt-spun nanocrystalline  $\text{Nd}_2\text{Fe}_{14}\text{B}$  magnets, while Sumitomo developed full-density sintered  $\text{Nd}_2\text{Fe}_{14}\text{B}$  magnets.

GM commercialized its inventions of isotropic Neo powder, bonded Neo magnets, and the related production processes by founding Magnequench in 1986 (Magnequench has since become part of Neo Materials Technology, Inc., which later merged into Molycorp). The company supplied melt-spun  $\text{Nd}_2\text{Fe}_{14}\text{B}$  powder to bonded magnet manufacturers.

The Sumitomo facility became part of the Hitachi Corporation, and currently manufactures and licenses other companies to produce sintered  $\text{Nd}_2\text{Fe}_{14}\text{B}$  magnets. Hitachi holds more than 600 patents covering neodymium magnets.

Chinese manufacturers have become a dominant force in neodymium magnet production, based on their control of much of the world's sources of rare earth mines.

The United States Department of Energy has identified a need to find substitutes for rare earth metals in permanent magnet technology, and has begun funding such research. The Advanced Research Projects Agency-Energy has sponsored a Rare Earth Alternatives in Critical Technologies (REACT) program, to develop alternative materials. In 2011, ARPA-E awarded 31.6 million dollars to fund Rare-Earth Substitute projects.<sup>[9]</sup>

## Production

There are two principal neodymium magnet manufacturing methods:

- Classical powder metallurgy or sintered magnet process
- Rapid solidification or bonded magnet process

Sintered Nd-magnets are prepared by the raw materials being melted in a furnace, cast into a mold and cooled to form ingots. The ingots are pulverized and milled; the powder is then sintered into dense blocks. The blocks are then heat-treated, cut to shape, surface treated and magnetized.



In 2015, Nitto Denko Corporation of Japan announced their development of a new method of sintering neodymium magnet material. The method exploits an "organic/inorganic hybrid technology" to form a clay-like mixture that can be fashioned into various shapes for sintering. Most importantly, it is said to be possible to control a non-uniform orientation of the magnetic field in the sintered material to locally concentrate the field to, e.g., improve the performance of electric motors. Mass production is planned for 2017.

As of 2012, 50,000 tons of neodymium magnets are produced officially each year in China, and 80,000 tons in a "company-by-company" build-up done in 2013. China produces more than 95% of rare earth elements, and produces about 76% of the world's total rare-earth magnets.

Bonded Nd-magnets are prepared by melt spinning a thin ribbon of the NdFeB alloy. The ribbon contains randomly oriented Nd<sub>2</sub>Fe<sub>14</sub>B nano-scale grains. This ribbon is then pulverized into particles, mixed with a polymer, and either compression- or injection-molded into bonded magnets. Bonded magnets offer less flux intensity than sintered magnets, but can be net-shape formed into intricately shaped parts, as is typical with Halbach arrays or arcs, trapezoids and other shapes and assemblies (e.g. Pot Magnets, Separator Grids, etc.). There are approximately 5,500 tons of Neo bonded magnets produced each year. In addition, it is possible to hot-press the melt spun nanocrystalline particles into fully dense isotropic magnets, and then upset-forge or back-extrude these into high-energy anisotropic magnets.

## **Properties**

Neodymium magnets are graded according to their maximum energy product, which relates to the magnetic flux output per unit volume. Higher values indicate stronger magnets and range from N35 up to N52. Letters following the grade indicate maximum operating temperatures (often the Curie temperature), which range from M (up to 100 °C) to EH (200 °C).

## **Hazards**

The greater forces exerted by rare-earth magnets create hazards that may not occur with other types of magnet. Neodymium magnets larger than a few cubic centimetres are strong enough to cause injuries to body parts pinched between two magnets, or a magnet and a ferrous metal surface, even causing broken bones.

Magnets that get too near each other can strike each other with enough force to chip and shatter the brittle material, and the flying chips can cause various injuries, especially eye injuries. There have even been cases where young children who have swallowed several magnets have had sections of the digestive tract pinched between two magnets, causing injury or death. The stronger magnetic fields can be hazardous to mechanical and electronic devices, as they can erase magnetic media such as floppy disks and credit cards, and magnetize watches and the shadow masks of CRT type monitors at a greater distance than other types of magnet.

That is why we recommend extra precaution when building the generator.

### **Working principle**

Using the technology electric cars use nowadays, the Easy DIY Power Plan was developed to be easier to build than any other generator plans.

Some of steel parts can be made from wood instead of metal. But for a long lasting and a more reliable it is best to use steel or strong materials. Please be careful!

The generator starts with a DC motor, which in the case of his first prototype is a General Electric permanent magnet, one-twelfth horsepower (62 watt) 12-volt motor which runs at 1100 rpm. That motor is coupled to a gear that transfers the spins, multiplying them to another gear that is attached to a flywheel's driveshaft.

The second part of the project will provide the energy to power the DC motor to ensure the spin of the whole system.

## List of components for the 2<sup>nd</sup> part of the project:

### Dc Motor 12-volt

([https://www.amazon.com/AUTOTOOLHOME-Electric-Drill-Motor-Drills/dp/B01LZYWFE4/ref=sr\\_1\\_2\\_sspa?ie=UTF8&qid=1537381092&sr=8-2-spons&keywords=12+volt+dc+motor&psc=1](https://www.amazon.com/AUTOTOOLHOME-Electric-Drill-Motor-Drills/dp/B01LZYWFE4/ref=sr_1_2_sspa?ie=UTF8&qid=1537381092&sr=8-2-spons&keywords=12+volt+dc+motor&psc=1))

You can find DC motor in many portable home appliances, automobiles and types of industrial equipment. Small DC motors are used in tools, toys, and appliances.

A DC motor is any of a class of rotary electrical machines that converts direct current electrical power into mechanical power. The most common types rely on the forces produced by magnetic fields. Nearly all types of DC motors have some internal mechanism, either electromechanical or electronic, to periodically change the direction of current flow in part of the motor.



DC motors were the first type widely used, since they could be powered from existing direct-current lighting power distribution systems. A DC motor's speed can be controlled over a wide range, using either a variable supply voltage or by changing the strength of current in its field windings. The universal motor can operate on direct current but is a lightweight motor used for portable power tools and appliances.

Larger DC motors are used in propulsion of electric vehicles, elevator and hoists, or in drives for steel rolling mills. The advent of power electronics has made replacement of DC motors with AC motors possible in many applications.

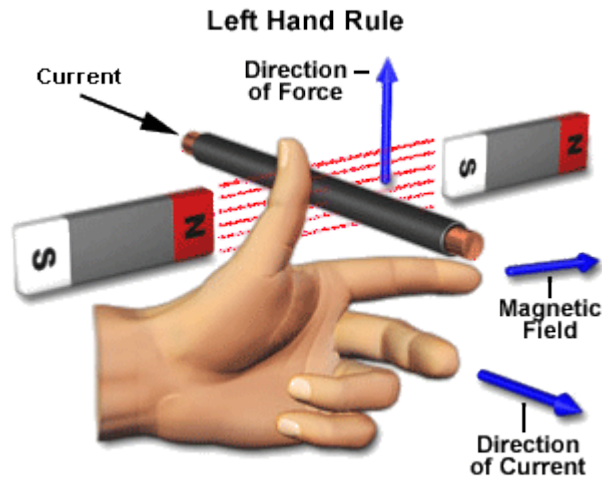

The direction of rotation of a this motor is given by Fleming's left hand rule, which states that if the index finger, middle finger and thumb of your left hand are extended mutually perpendicular to each other and if the index finger represents the direction of magnetic field, middle finger indicates the direction of current, then the thumb represents the direction in which force is experienced by the shaft of the DC motor.

Structurally and construction wise a direct current motor is exactly similar to a DC generator, but electrically it is just the opposite. Here, unlike a generator, we supply electrical energy to the input port and derive mechanical energy from the output port. We can represent it by the block diagram shown below.

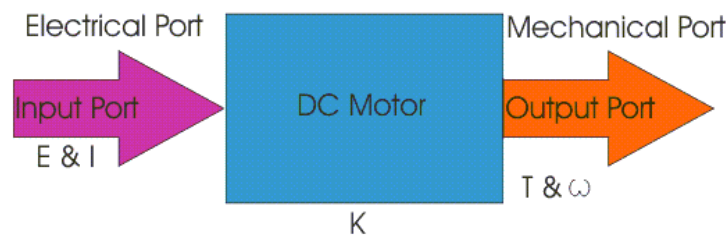

Here in a DC motor, the supply voltage  $E$  and current  $I$  is given to the electrical port or the input port and we derive the mechanical output i.e. torque  $T$  and speed  $\omega$  from the mechanical port or output port.

The input and output port variables of the direct current motor are related by the parameter  $K$ .

$$T = KI \text{ and } E = K\omega$$

So from the picture above we can well understand that motor is just the opposite phenomena of a DC generator, and we can derive both motoring and generating operation from the same machine by simply reversing the ports.

To understand the DC motor in details let's consider the diagram below:

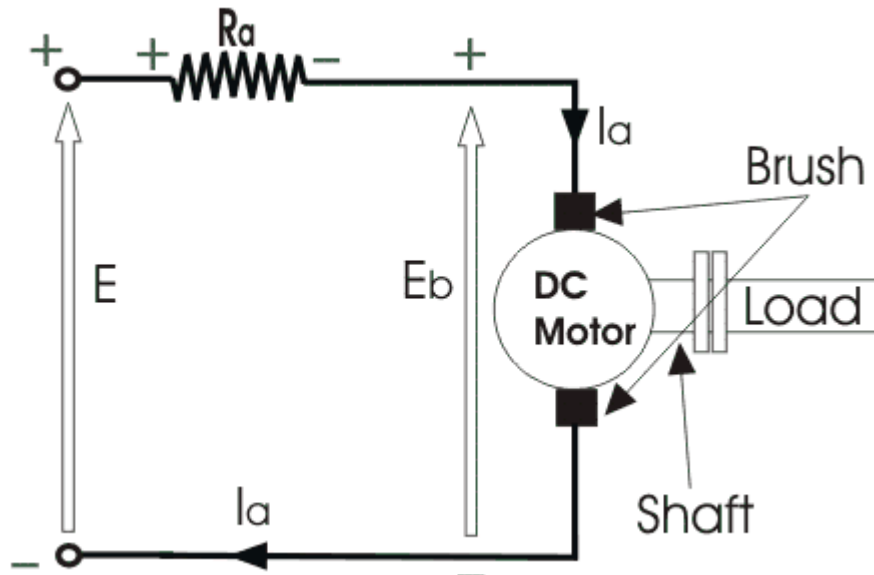

The direct current motor is represented by the circle in the centre, on which is mounted the brushes, where we connect the external terminals, from where supply voltage is given. On the mechanical terminal we have a shaft coming out of the Motor, and connected to the armature, and the armature-shaft is coupled to the mechanical load. On the supply terminals we represent the armature resistance  $R_a$  in series.

Now, let the input voltage  $E$ , is applied across the brushes. Electric current which flows through the rotor armature via brushes, in presence of the magnetic field, produces a torque  $T_g$ . Due to this torque  $T_g$  the dc motor armature rotates. As the armature conductors are carrying currents and the armature rotates inside the stator magnetic field, it also produces an emf  $E_b$  in the manner very similar to that of a generator. The generated Emf  $E_b$  is directed opposite to the supplied voltage and is known as the back Emf, as it counters the forward voltage.

The back Emf like in case of a generator is represented by

$$E_b = \frac{P \cdot \phi \cdot Z \cdot N}{60 \cdot A} \dots \dots \dots (1)$$

Where, P = no of poles



$\phi = \text{flux per pole}$

$Z = \text{No. of conductors}$

$A = \text{No. of parallel paths}$

and  $N$  is the speed of the DC Motor.

So, from the above equation we can see  $E_b$  is proportional to speed 'N'. That is whenever a direct current motor rotates, it results in the generation of back Emf. Now lets represent the rotor speed by  $\omega$  in rad/sec. So  $E_b$  is proportional to  $\omega$ .

So, when the speed of the motor is reduced by the application of load,  $E_b$  decreases. Thus the voltage difference between supply voltage and back emf increases that means  $E - E_b$  increases. Due to this increased voltage difference, armature current will increase and therefore torque and hence speed increases. Thus a DC Motor is capable of maintaining the same speed under variable load.

Now armature current  $I_a$  is represented by

$$I_a = \frac{E - E_b}{R_a}$$

Now at starting, speed  $\omega = 0$  so at starting  $E_b = 0$ .

$$\therefore I_a = \frac{E}{R_a} \dots \dots \dots (2)$$

Now since the armature winding electrical resistance  $R_a$  is small, this motor has a very high starting current in the absence of back Emf. As a result we need to use a starter for starting a DC Motor.

Now as the motor continues to rotate, the back Emf starts being generated and gradually the current decreases as the motor picks up speed.

On our project we used a one-twelfth horsepower (380 watt) 40A, 12-volt motor which runs at 1600 rpm.



You can also use other types of DC Motor, provided that they have these characteristics:

- 12V
- 60-80 Amps
- Minimum 650 RPM

The main criteria by which you need to choose the DC Motor is that it needs to be able to input to the flywheel minimum 2500 RPMs.

It's one of the most important parts because the math must be precise to reach the optimum RPMs for device.

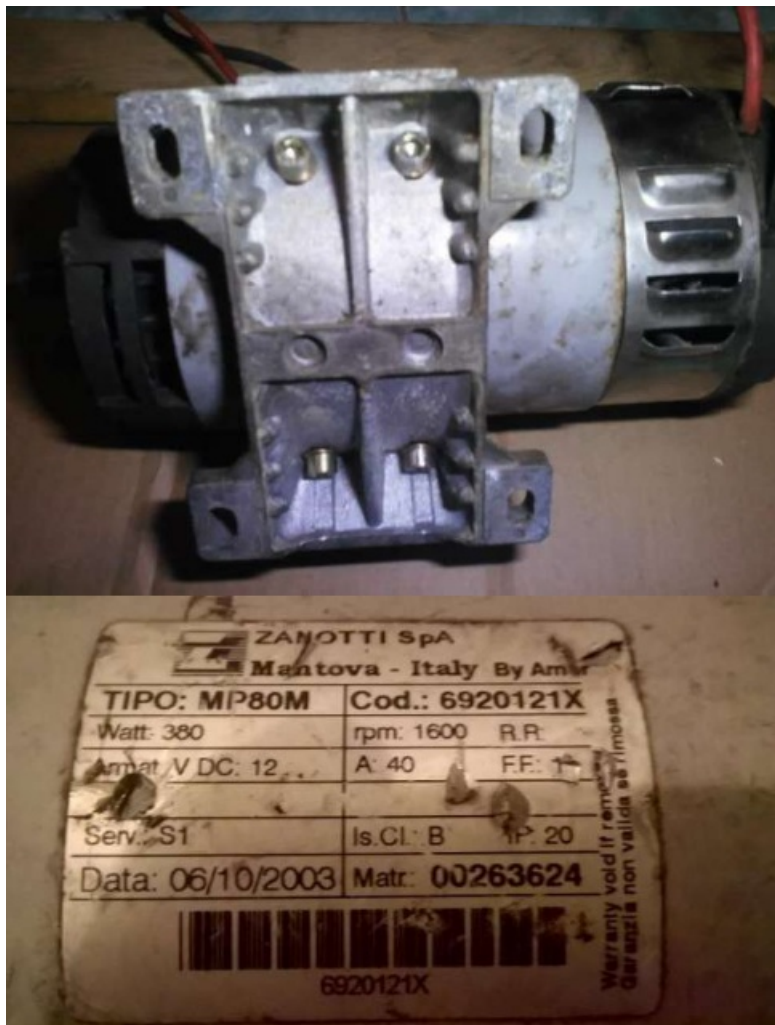

**Gears with Sprocket Chains (you can also use rollers belts)**

[https://www.amazon.com/1989-1993-Polaris-Chains-Complete-Sprocket/dp/B077W2BK2X/ref=sr\\_1\\_1\\_sspa?ie=UTF8&qid=1537381205&sr=8-1\\_spons&keywords=sprocket+chain&psc=1](https://www.amazon.com/1989-1993-Polaris-Chains-Complete-Sprocket/dp/B077W2BK2X/ref=sr_1_1_sspa?ie=UTF8&qid=1537381205&sr=8-1_spons&keywords=sprocket+chain&psc=1)

For our initial tests, as seen in the presentation, we used belts, but after thorough investigation, we reached the conclusion that using Gears with Sprocket Chains is safer and a lot more efficient.

The means of transmitting the spin is very important. This transmission is crucial for the functionality of the generator. The connection between the DC motor's shaft and the flywheel's shaft is more efficient using Gears with Sprocket Chains because you can easily adjust it to reach the 2000 RPMs.

For the DC motor's Gear you can use an old (or new) bicycle gear with 32 spikes or 42. You can find them with standard dimensions.

The gear that will be attached to the flywheel must be two or three times smaller than the gear used on the DC motor.

The difference between the 2 gears cannot be too big because the power of the DC motor would not be enough to spin the flywheel.

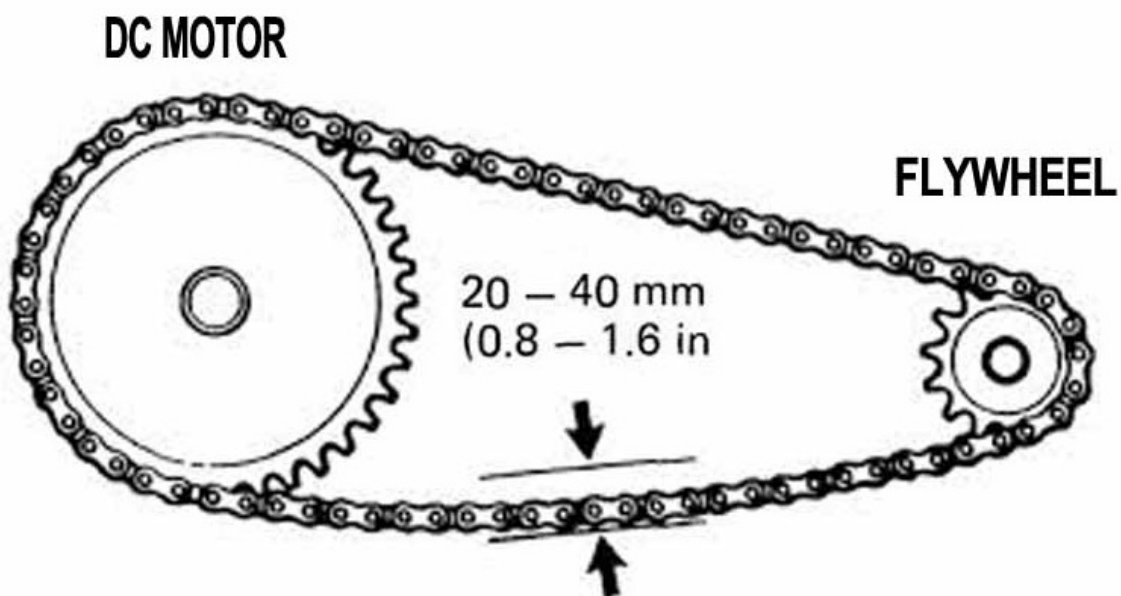

If the size of the gears is somehow not enough to start the spin, you may carefully help the flywheel by imprinting an initial spin (No more than 2 touches!). Please pay extra attention not to make contact with the flywheel more than 2 times because the flywheel will speed up and accidents may occur. We also advise using gloves and avoiding as much as possible this method of speeding up the flywheel.

If the first gear has 32 spikes the small one must have 11 spikes and if you choose to use the 42 spike gear, for the second gear you must use a 15 spike one.

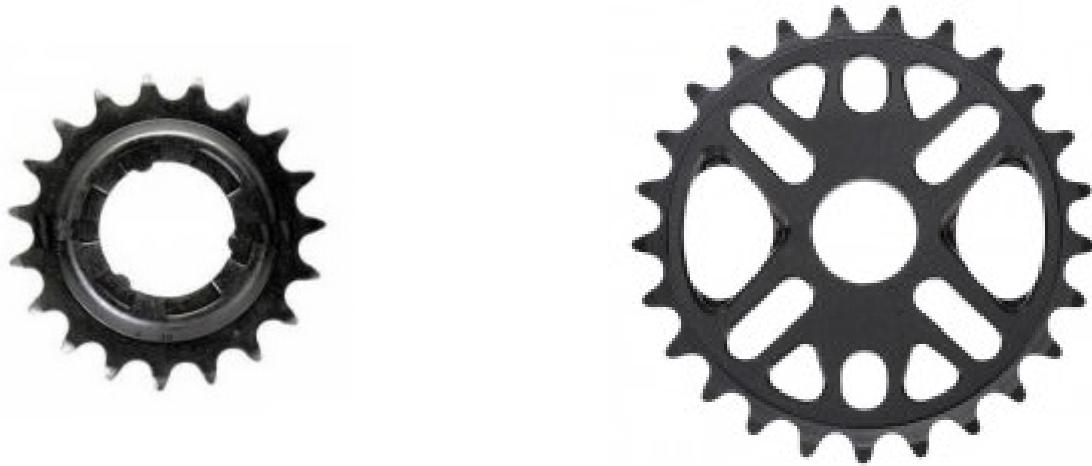

You can also use other gears, provided that the ratio between the 2 gears supplies the 2000 RPMs needed.

The chain (or, as used in the initial devices, the belt) must not be tight and tensioned. As presented in the picture above, the chain needs to oscillate at a maximum of 1.6 inches and a minimum of 0.8 inches.

For a proper functioning, the chain needs to be periodically greased

Both gears and the chain need to be firmly placed and protected with a casing (that ensures its functionality) to avoid any risks.

**Flywheel - [https://www.amazon.com/LuK-LFW162-Flywheel/dp/B000QQD7FS/ref=sr\\_1\\_12?ie=UTF8&qid=1537381280&sr=8-12&keywords=Flywheel](https://www.amazon.com/LuK-LFW162-Flywheel/dp/B000QQD7FS/ref=sr_1_12?ie=UTF8&qid=1537381280&sr=8-12&keywords=Flywheel)**

The principle of the flywheel is found in the Neolithic spindle and the potter's wheel.

A flywheel is a rotating mechanical device that is used to store rotational energy. Flywheels have an inertia called the moment of inertia and thus resist changes in rotational speed. The amount of energy stored in a flywheel is proportional to the square of its rotational speed. Energy is transferred to a flywheel by the application of a torque to it, thereby increasing its rotational speed, and hence its stored energy. Conversely, a flywheel releases stored energy by applying torque to a mechanical load, thereby decreasing the flywheel's rotational speed.

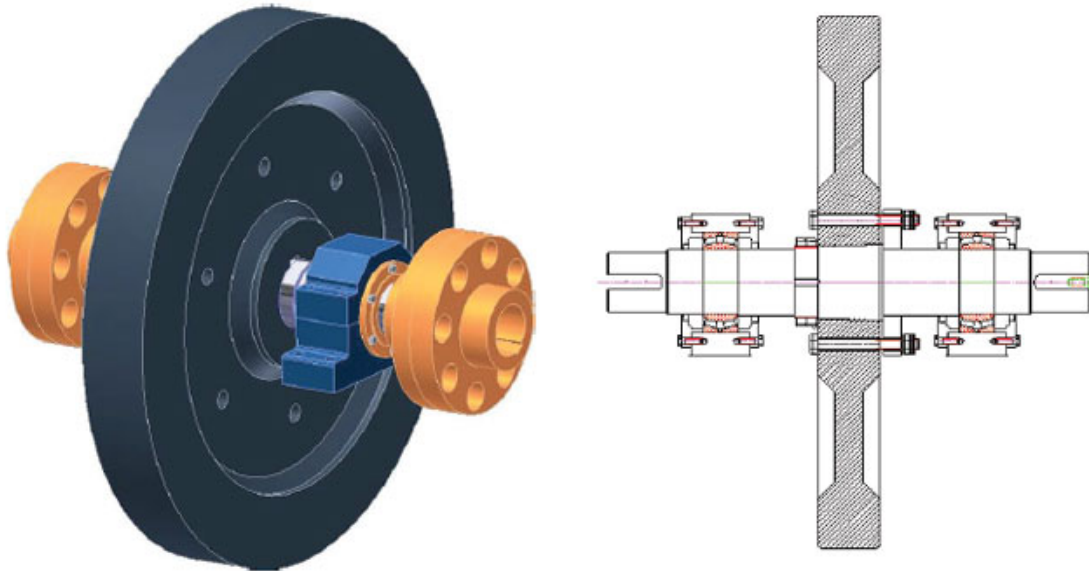

The efficiency of a flywheel is determined by the amount of energy it can store per unit weight. As the flywheel's rotational speed or angular velocity is increased, the stored energy increases; however, the centrifugal stresses also increase. If the centrifugal stresses surpass the tensile strength of the material, the flywheel will break apart. Thus, the tensile strength determines an upper limit to the amount of energy that a flywheel can store.

The inclusion of the flywheel is said to be in order to keep the motor running well when it is being pulsed rather than having a continuous feed of electricity from the battery.

The flywheel draws energy in from the local gravitational field.

Every particle making up the rim of the flywheel is accelerating inwards towards its axle and that happens continuously when it rotates.

### **Rotors**

The diameter of the rotor we used for this project is 6 inch.

You can make it bigger; it is expected to produce more power when the rotor is bigger in diameter.

This is the front view about how the magnetic rotors would rotate. In series each rotor rotate in the opposite direction of the one after or before.



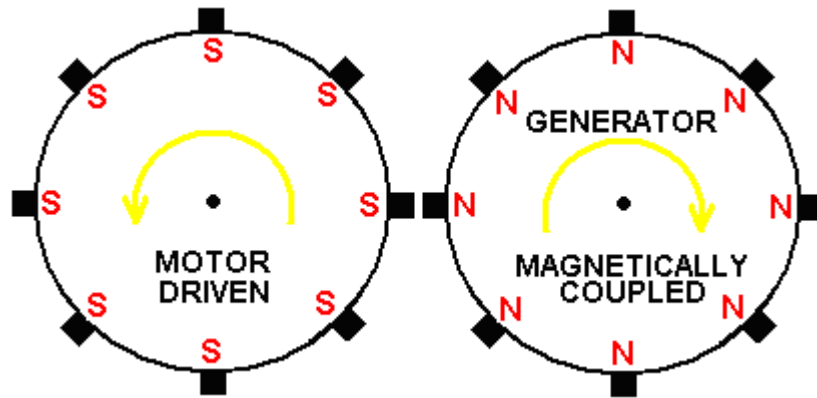

All the magnets are mounted in ATTRACTION with all south or north outwards from one rotor to the other.

It is very important to use neodymium magnets because of their properties.

[https://www.amazon.com/DIYMAG-Brushed/dp/B07B3W79TP/ref=sr\\_1\\_19?ie=UTF8&qid=1537381507&sr=8-19&keywords=neodymium+magnets](https://www.amazon.com/DIYMAG-Brushed/dp/B07B3W79TP/ref=sr_1_19?ie=UTF8&qid=1537381507&sr=8-19&keywords=neodymium+magnets)



It is also advised to put a case or box around the rotors for safety reasons.

To generate even more electricity you can make some adaptations:

- Increase the number of magnets
- Increase the number of disks
- Increase the power of the magnets
- Increase the number of rotors
- Increase the diameter of the rotors



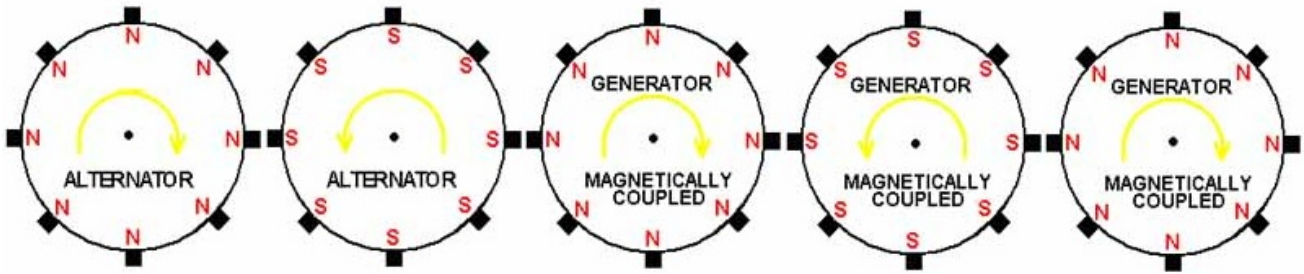

This is a schematic that shows how the rotor is fixed on the shaft of the generator and the one of the alternators.

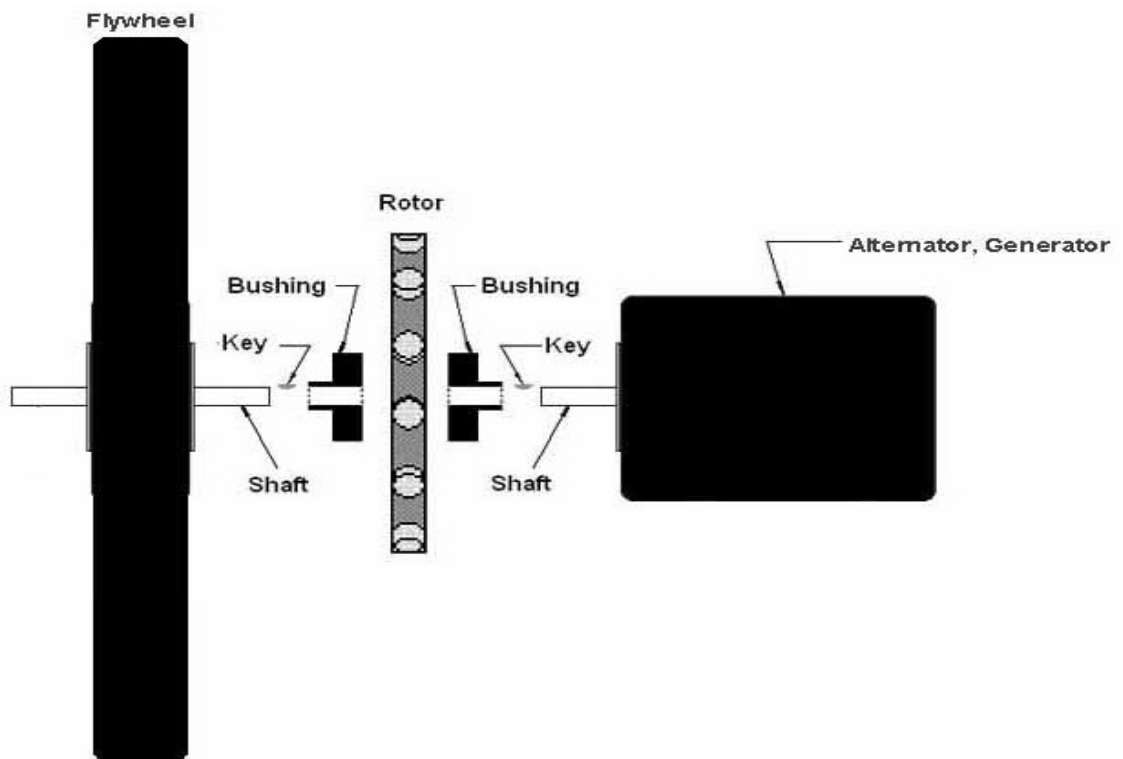

For higher RPMs which leads to more power, the rotors on the sides of the main rotor will need to have a smaller diameter.

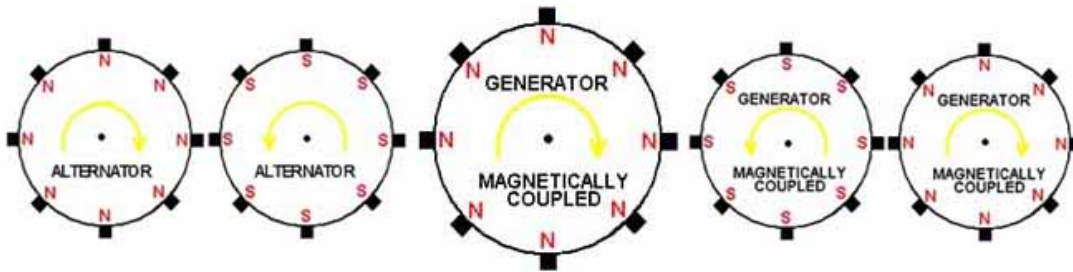

**Alternator - [https://www.amazon.com/Value-Grade-Remanufactured-Alternator-7078V/dp/B00U1RY85A/ref=sr\\_1\\_1?s=automotive&ie=UTF8&qid=1537381577&sr=1-1&keywords=Alternator&dpID=512-PbYE4fL&preST= SY300 QL70 &dpSrc=srch](https://www.amazon.com/Value-Grade-Remanufactured-Alternator-7078V/dp/B00U1RY85A/ref=sr_1_1?s=automotive&ie=UTF8&qid=1537381577&sr=1-1&keywords=Alternator&dpID=512-PbYE4fL&preST= SY300 QL70 &dpSrc=srch)**

The alternator is the main component of a generator that provides electricity.

The alternator is an electric device three-phased that is driven by the combustion engine via the accessory belt.

Depending on the electronic equipment on a vehicle, electricity consumption can reach maximum values of 1.7 - 2 kW. The alternator must be able to produce this extra energy to charge the battery.

An alternator must have the following characteristics:

- It needs to produce enough energy to power all electric consumers
- It needs to produce enough energy to charge the battery, regardless of the consumption of the electrical systems that are connected to it.
- It needs to produce enough energy regardless of the RPMs needed for functionality.
- It needs to have the power/mass ratio as small as possible.
- It needs to be reliable, to run as silent as possible
- No maintenance

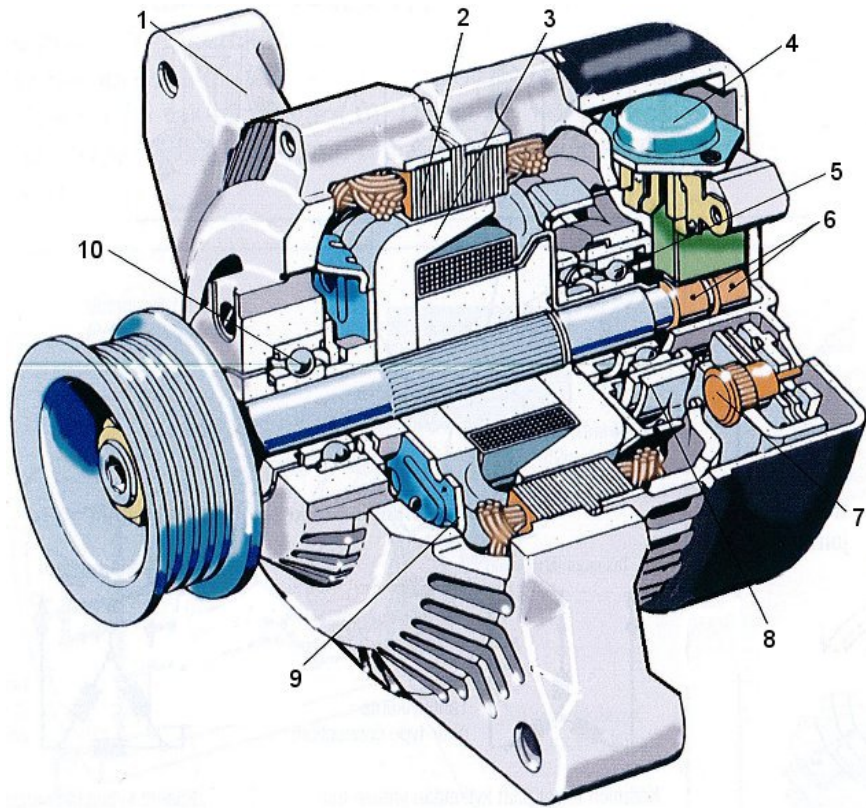

1. Casing
2. Stator
3. Rotor
4. Voltage regulator
5. Bearing
6. Slip ring
7. Bridge rectifier
8. Back fan
9. Front fan
10. Bearing

The stator is made of metal plates wound with copper conductors which represent the three phases of the alternator (A, B and C). The stator windings of the three phases are connected in star, each phase having a wire connection with the bridge rectifier.



To produce more power the stator windings need a rotating magnetic field. The magnetic field is produced by the rotor. Positioned on the shaft, the rotor comprises a wound rotor and a pair of claw-shaped poles. Each pair of successive claws forms the two apparent magnets (N, S) which generate a magnetic field. In order to have a higher efficiency of the rotor contains 12 to 16 poles.

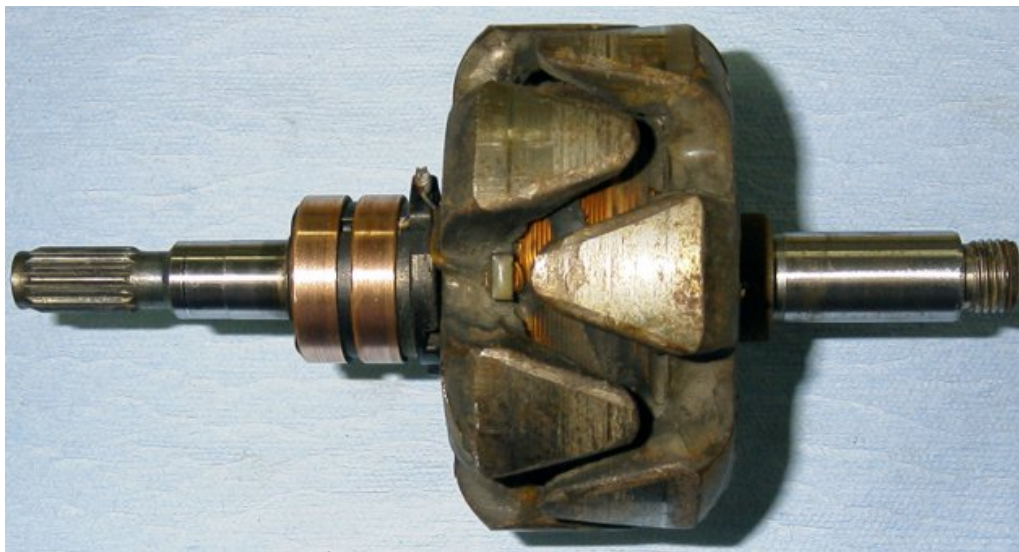

The operating principle is relatively simple. The magnetic field generated by the rotor produces on each phase of the stator a sinusoidal electric current. All electrical components of the device are DC. Switching from AC to DC is done using a diode bridge rectifier.



The bridge rectifier contains 6 diodes that are integrated in an aluminum radiator. For each phase of the alternator 2 diodes are used to convert the alternating current into electric current.

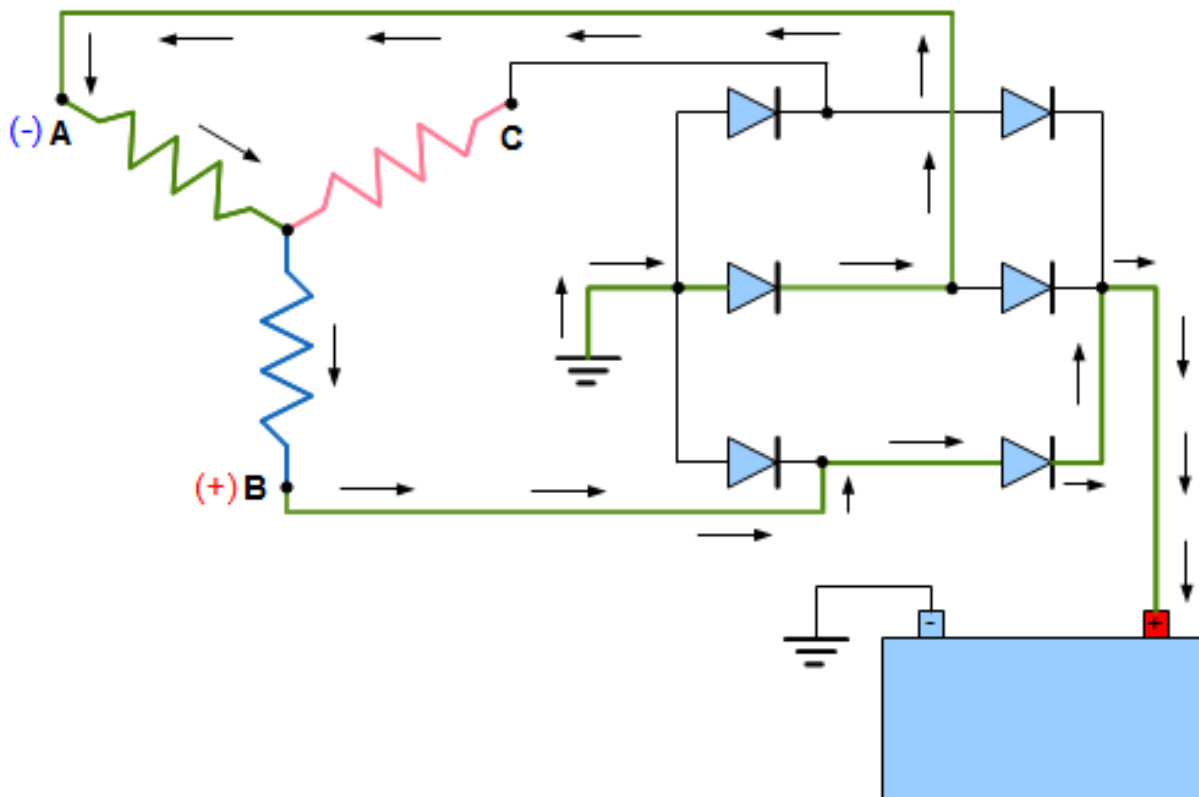



The frequency of the electric current depends on the rotor speed and the number of magnetic poles.

To prevent overloading the battery, the voltage from the alternator must remain constant all the time, regardless of the operating conditions of the device and the electricity consumption.



The voltage regulator is designed to control the power supply of the rotor. It controls the rotor's magnetic field, implicitly the voltage induced in the stator. The voltage generated by the alternator must be maintained around 14.2 V. The voltage regulator is integrated into the alternator casing.

### **List of components for the 2<sup>nd</sup> part of the project:**

You will need the following items:

- Solar panels
- Reflective panes
- Stands
- Hinges
- Cables
- Battery



- Inverter
- Test Kit

# The generator

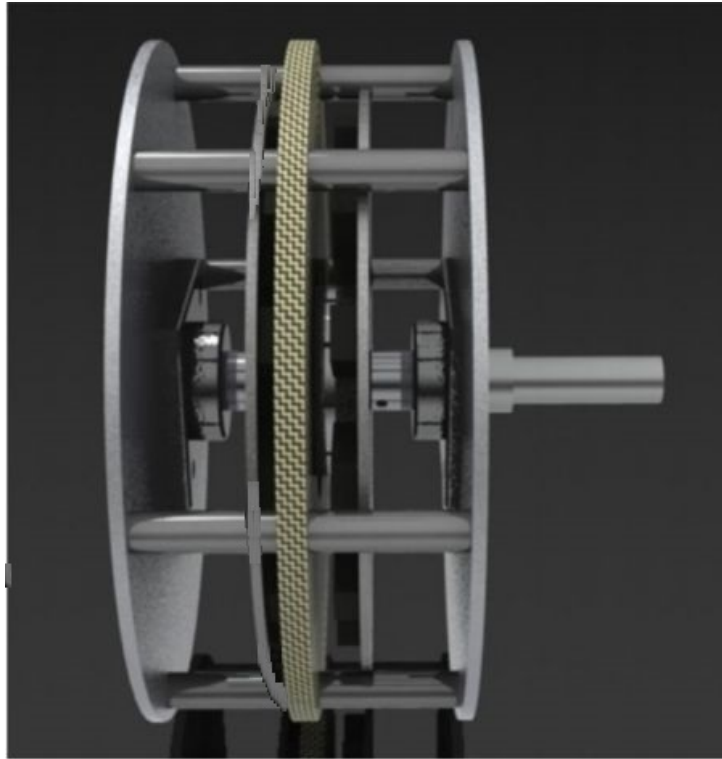

## 1. End caps

The end caps are aluminum plates. You will need 2 such plates and you will position them at each end of the generator. The flange bearings are fixed to the end caps as well as to the protective case with stator mounting bolts. The flange bearings are fixed at the 4 bolts that are visible in the picture. You will be presented with a radius but it can be changed, depending on the flange bearing you will use. The 6 outer bolts presented in the picture if for the 6 bolts that will support the stator. You can build these plates from aluminum by drawing the dimension on a square sheet of aluminum. You can use a handsaw or jig saw. The overall shape of the end caps is not crucial because none of the two will rotate. However, a large difference between them the outer casing will not fit:

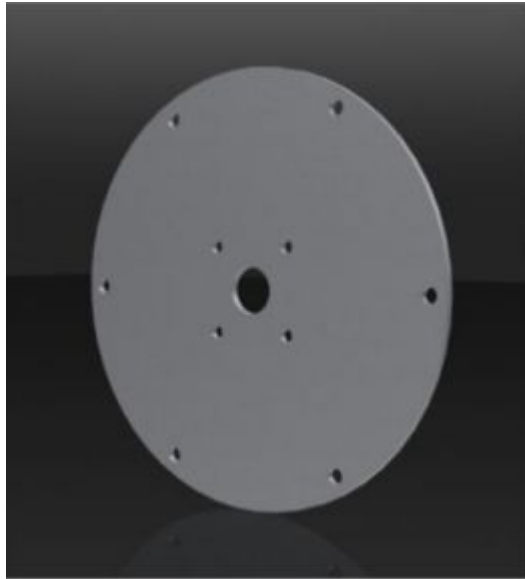

## 2. Rotors

Each of the two rotors will be a thin steel plate (1/8 inch thick and 12 inches in diameter). As shown in the picture, a radial pattern on magnets will be placed on each rotor. The rotor is then placed into a mold and Devcon Flexane-80 liquid will be poured on top of the rotor until the magnets will barely be seen. The Flexane-80 liquid urethane resin must be of medium consistency. This will allow the plates to expand or contract, depending on the weather condition:

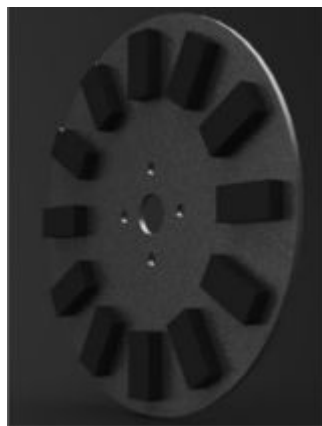

The above picture shows the rotor before the Flexane-80 liquid is added. The 4 bolts circling the center of the rotor plate are used to fix the plates to the flange (which will be attached to the driveshaft).

You can use the same dimension for the steel plate (1/8 inch thick).

You can use any type of magnet (the stronger, the better). We recommend using 45 neodymium-boron rare earth magnets. You will need 12 for each rotor resulting in a total of 24. You must arrange the magnets at 3.5 inches from the center of the plate. The dimensions of the magnets are 2" x 1" x 1/2" (L x W x T). Their thickness will provide the magnetic force.

As you position the magnets make sure you alternate the poles. This means that they must alternate N, S, N, etc. as they go around. In order to properly arrange the magnets, a wooden jig will be used (it will later be presented). The jig will be placed using 4 pins that will go through the 4 bolt holes presented in the picture. Then simply arrange the magnets and remove the jig.

Here is a picture of the pattern of the magnets, as they should be placed:

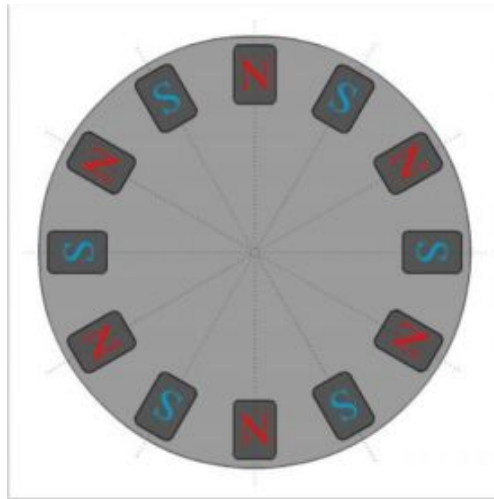

The jig will simplify the placing process and it can be used for both rotor plates. You need to create the rotor plates opposite of one another and take special care in arranging the magnets. First, select a starting point on the wooden jig for the first magnet and continue with the second one, placing it with the opposite pole. Continue by alternating the poles of the magnets until the circle is complete. The second rotor plate must be built in the same manner, except from the fact that the first magnet must be placed on the opposite pole as to the first magnet on the first plate. This will result in a complete opposite placement of the magnets (from the first rotor plate) - opposite poles all face one another, enhancing the magnetic flux.

Safety advice: Because the magnets are powerful, take care when handling them around the garage. Also take care when placing the magnets of the rotor plates because they can crack/shatter and decay their magnetic potential over time.

Next we will present the parts needed for casting the rotors. (a full plan with dimensions is included at the end of the PDF file)

### 3. Magnet jig and mold hardware

The wooden jig is a round piece of wood with slots cut into to facilitate the placement of the magnets. The inner 4 bold circle has a 1.375" radius - the same as the rotor plates. Because 12 magnets are used, you need to cut 12 slots into the jig at a 30 degree angle around the circumference. This way you can fix the jig with the bolts to the rotor plate and fit the magnets into the slots. Gently remove the jig after fitting all magnets.

The overall diameter of the jig is not relevant, but the distance from the center of the jig to the inner edge of the slots is crucial because the magnets must be placed equally from the center of the plate:



The next picture presents a second suggestion for the jig. This second idea provides an easier removal of the jig after the magnets are placed:



**4. The bolt circle** around the outside of the rotor mold base is used to bolt the entire mold together. The inner bolt circle will hold pins that will act as “dummy bolts” for the casting process and keep bushings in perfect alignment. A plug goes in the center hole which will allow the cast to mount to the flange. This part has a stepped thickness that corresponds with the top half that allows the two parts to lock together. This will prevent flexane from leaking out of the mold and keep the metal plate centered. This part is cut from MDF and stepped using a rotary table but can be left flat if the right equipment isn't present:



The top part of the mold can be cut from MDF. It has the same bolt circles, at the same distance as the one on the bottom. This second piece is a little thicker in order to lock to the one on the bottom. It is not necessary for it to be thicker. If not possible, you can make this part flat. It is important to have the same dimensions as the one on the bottom:

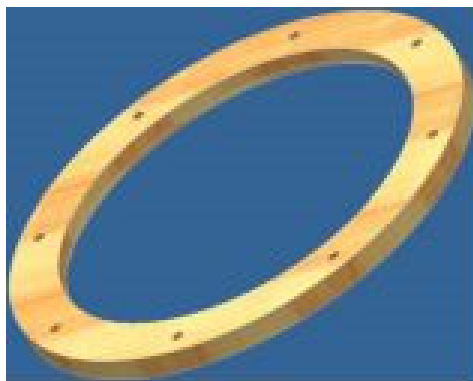



The material for these pins is not relevant. They must fit the bushings and they need to be placed and removed easily from them:



The bushings you need must slide over the pins during the casting process and have knurls to be properly bonded with the Flexane-80. You must use steel bushing to avoid corrosion:

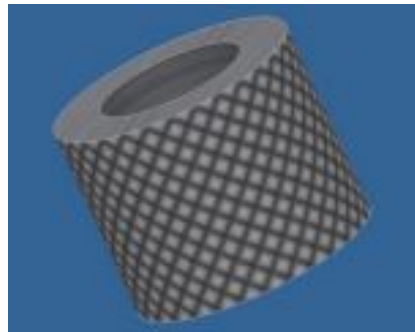

## 5. Mold assembly

We will present in the next section the steps to build the rotor mold.

The surface of the rotor plates must be roughened using sand paper.

A. First, place the steel rotor plate on the base of the mold and insert all 4 pins and the center plug through the holes until you have a plane surface on the bottom.

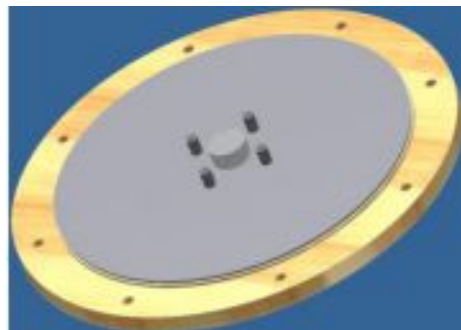

B. Next, place the wooden jig onto the rotor plate and fix it using the pins.



C. Start placing the magnets by alternating the poles. Before placing the magnets make sure to set the first magnet as the top one and remember its pole because you will need the second rotor plate to start with the opposite pole.

Place the magnets into the jig's slots by alternating the poles. You can check the polarity by hovering another magnet around the plate and checking the attraction and repulsion.

**BE CAREFUL NOT TO LET THE MAGNET SLIP FROM YOUR HAND!** This could damage the magnets in the jig and ruin the rotor.



D. Next, remove the wooden jig and place the knurled bushing onto the pins. Place the top of the mold and fix it using screws. You are now ready to pour the Flexane-80 liquid.

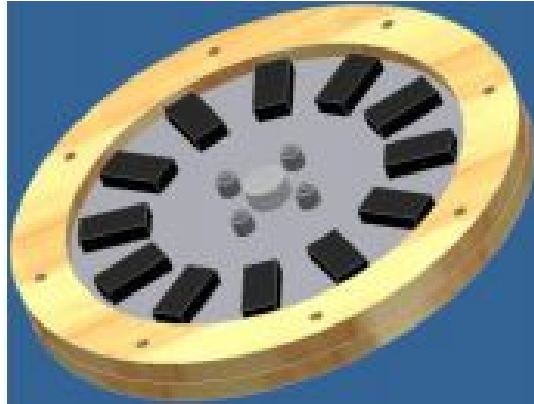

## 6. Casting - preparation of the mold:

### MATERIALS:

- 2 brushes with wood handles
- 2 Plastic mixing buckets
- Johnson paste wax (or similar) and rags
- Liquid silicon mold release
- Hot air gun
- Flexane 80 Liquid Resin
- Devcon FL-10 Primer
- Finished metal plates
- Magnet Jig
- Metal Bushings
- Metal Pins

## 7. Preparing the mold and the surfaces

A. After preparing the MDF mold, apply Johnson paste wax on any area that the Flexane will come in contact with. Repeat this process after 10 minutes .



B. Put the mold together and rub more of the Johnson paste wax all around the mold, especially at the jointure of the two pieces of MDF. This will prevent the Flexane from leaking. Leave it for 10 minutes to dry.

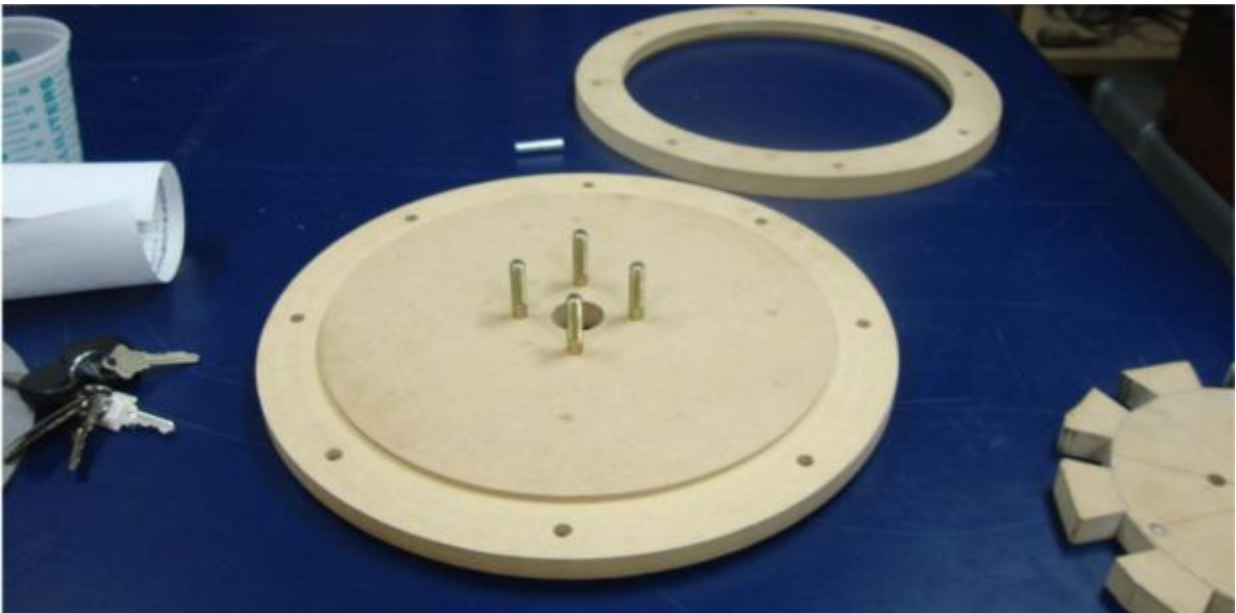

C. Spread the liquid silicon onto the mold (once only).



## 8. Prime surfaces

Make sure again that no loose metal objects are near the magnets.

1. Place the rotor into the mold.
2. In a separate cup pour some Devcon FL-10 primer
3. Apply with a fresh brush some Devcon FL-10 on the steel rotor plate and the bushings.



4. Let it dry. After 15 minutes, apply a second layer.
5. Prop up the mold on one side so there is a slight tilt before pouring the.

6. Put the mold together. Place the bolt ring around the wooden base of the rotor. Next place the 4 pins into the 4 holes of the wooden base of the rotor. Beforehand coat them with a layer of mold release. Place the plug into the middle hole and apply a layer of mold release.

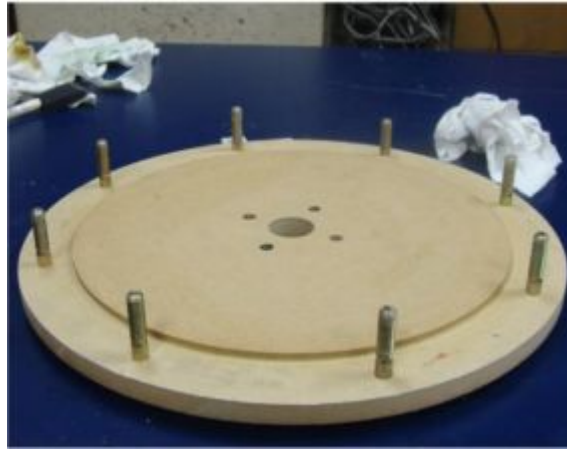

Place the second wooden ring on the first wooden ring and fix them using the nuts.

6. Cover the top of each magnet not to stain the magnets when pouring the material around them.

### **9. Mixing and pouring**

1. In a different plate mix 2 bottles of Flexane and catalyst (as mentioned on the packages) for 2 minutes. You need 2 bottles for each rotor mold.

2. Take the mixed material to the wooden mold (that is already assembled). You will also need other brushes.

3. Apply a thin layer of Flexane on the mold - the metal and wooden part.

3. Pour the Flexane into the mold, and take extra care not to cover the magnets and leaving the top of the magnets slightly higher than the surface of the Flexane.





4. Level the Flexane.

5. You need a hot air gun to bring air bubbles out of the Flexane. Apply the hot air for 5 to 10 minutes.

6. Remove the mold after 10 hours.

7. You will need at least 16 hours before using the rotor plate.

## 10. STATOR

The stator is an epoxy resin casting with nine coils arranged inside. You can use as much coils as you want, provided that you use a multiple of three (because the three phase power is produced). The casting will have 6 bolts towards the outside area, similar to the end caps - same diameter, same holes. You may want to add 6 bushings to strengthen the casting on the whole device.

You also need to place small metal pieces in the center of each coil to help concentrate the flux through the center of each coil, which will improve the performance of the generator.



## 11. The molds for the epoxy resin casting

A. The mold base is made from the same material as the other mold - MDF. The outer bolt circle presented in the picture is needed to join the whole mold together and to fasten it together. The inner bolt circle (smaller holes) will hold the pins that will align the bushings. They will be removed after making the casting. The middle hole is for the center plug and it will serve for the flange.



B. This wooden circle needs to be placed in 2 layers (as presented later). It needs to go over the outer bolt holes on the base so they can be fastened together. You will need 2 such wooden circles.



C. The central plug can be made out of any materials lying around. Take care at its dimensions because its diameter will increase after applying the mold release.



D. The outer pins can be made of any materials because they will be removed. However, the bushing must be made of steel because they will be part of the casting. You can also knurl these bushings for higher resistance into the casting.

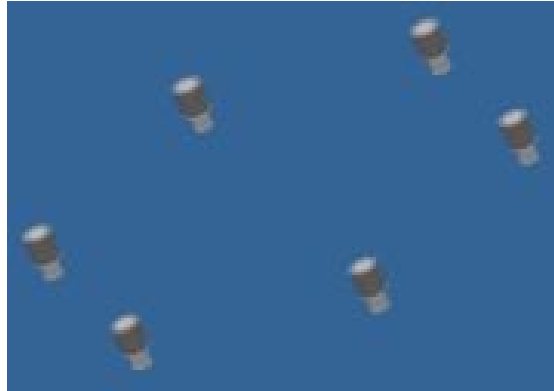

## 12. Making the coils.

A. You can make the coils by winding them on a magnet jig which can be made by hand from scrap material.

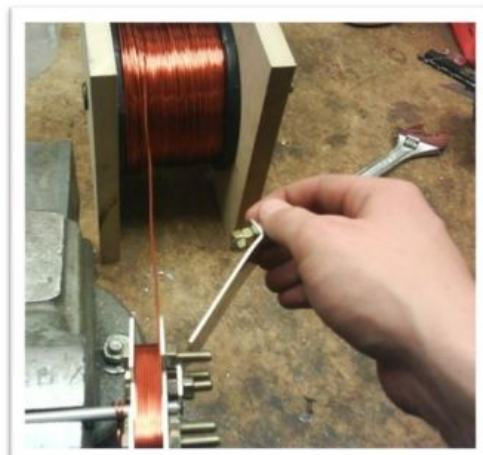

B. Each coil needs 100 turns of 16 AWG enameled magnet wire. The tighter, the better.



### **13. The resin casting**

#### **EPOXY TERMINOLOGY**

##### **A. Open time**

Open time or wet lay-up time describes the working life of the epoxy mixture. It is the portion of the cure time, after thorough mixing, that the resin/hardener mixture will remain in a liquid state and be workable or suitable for application. The end of the open time (wet lay-up time) marks the last opportunity to apply clamping pressure to a lay-up or assembly and obtain a dependable bond.

##### **B. Initial cure phase**

The open time is over when the mixture passes into an initial or partial cure phase (sometimes called the green stage) and has reached a gel state. At this point the epoxy will no longer feel sticky, but you will still be able to dent it with your thumb nail. It will be hard enough to be shaped with files or planes, but too soft to dry sand. Because the mixture is only partially cured, a new application of epoxy will still chemically link with it, so the surface may still be bonded to or recoated without sanding.

##### **C. Final cure phase**

In the final cure phase, the epoxy mixture will have cured to a solid state and will allow dry sanding and shaping. You should not be able to dent it with your thumbnail.

At this point the epoxy will have reached about 90% of its ultimate strength, so clamps can be removed. The epoxy will have to be left to strengthen at room temperature. A new application of epoxy will not chemically link to it, so the surface of the epoxy must be sanded before recoating to achieve a mechanical, secondary bond.

#### 14. Mold assembly

Next, we will present the steps for fixing the mold together

A. Place the pins into the inner bolt circle until you have a plane surface on the bottom of the mold and place the bushings over them. This way, you ensure a fixed placement of the bushings.



B. Place the central plug to obtain the same plane surface on the bottom. Place the first wooden ring and fix it to the base of the mold using the bolts. Before placing the coils into the mold, pour a 1/8 inch thick layer of resin and let it harden.



C. After the resin hardens and remove the nuts from the bolts holding the stator mold together. Fix the coils on the hardened resin and place the wires as shown in the picture - around the small bolts.

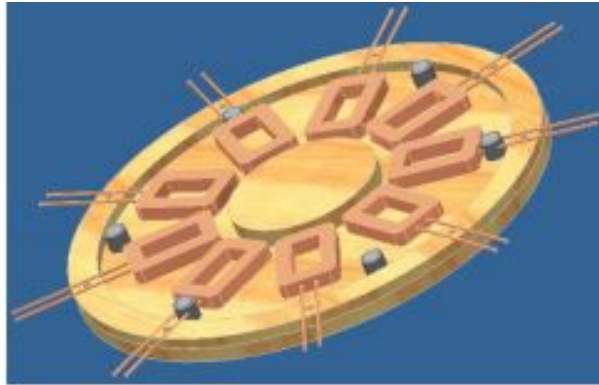

D. Lastly, place the second wooden circle over the first circle. This will ensure a tight fixture. The second wooden circle goes over the wires. After the second wooden circle is tightly fixed with nuts, you can pour the rest of the resin into the mold.



## 15. Preparing the mold

Materials:

- West Systems Epoxy 105 resin
- Spray Adhesive
- West Systems 206 slow hardener
- Ruler
- West Systems pump set
- Utility Knife
- Polyethelene film, 2 mil
- Vaseline Mold
- release paste

A. Before assembling the mold, apply mold release paste onto the parts of the mold that the resin will reach. Repeat 2 times, after 10 minutes of soaking.



B. Clean bushings with a solvent.

C. Draw the patterns of the coils on the Polyethelene film. Apply on the other side adhesive spray then spread the film on the base of the mold. Remove any wrinkles that might have remained.

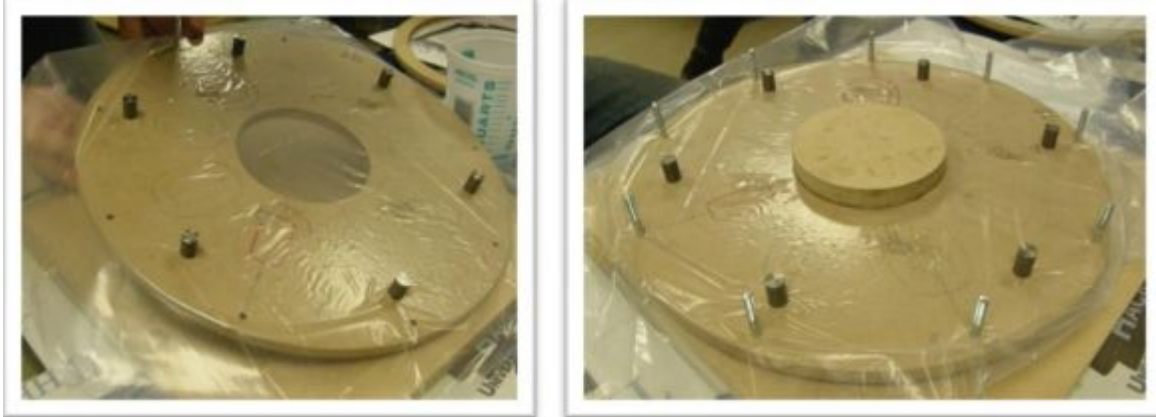

D. To prevent any leaks, pour mold release in excess on the bottom of the mold, where the outer pins are placed. Remove the extra mold release after placing and fixing the first outer wooden circles.

E. Grease the inside of the bushings with vaseline and place them together with the pins.

F. Place the center plug into the central hole after coating it with mold release paste.

G. Place all coils into the mold, as shown in picture and place the second wooden circle on the loose wires. The center plug must be at the same level as the second wooden circle. Now look carefully if the coils are placed 1/8" below the level of the mold. Remove the coils after removing the second wooden circle.



Pouring epoxy – dry time test

H. You need to pour this stator in 2 layers. The first layer must set up to tack-free before you pour the next level. This is to create a chemical bond between the 2 layers and to ensure that the coils will not sink.

I. Following the step by step instructions, mix up a test batch to calculate the time it takes to dry. The next step is to pour a 1/8" layer of epoxy and measure the time it takes to dry. The epoxy will start from the consistency of syrup, then form peaks, then finally hold its shape with the consistency of jello. By this time the epoxy you have already poured will become tack free and you can pour the second layer. Time will vary with temperature, humidity and time of mixing.

Pouring epoxy – first layer

J. Assess the volume and prepare the quantity. If not sure, add 10% to cover the errors.

K. Using the West Systems epoxy system, take one pump from resin, then one pump from hardener. 1 pump resin + 1 pump hardener = 0.8 fl oz = 1.44 in<sup>2</sup> . After 3 minutes of mixing, scrape the sides. Transfer the mix to another container, then mix for 1 minute. By transferring the mix to another container alleviates the problem of unmixed resin in corners is avoided.

L. Next pour into the mold and let it sit for the test dry time to set up to tack free. Note that in the next picture, the resin is hard to see since it is clear.

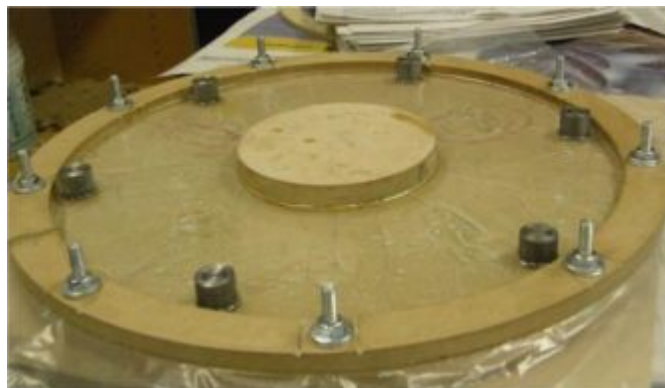

Pouring epoxy – second layer

M. Place the coils into the mold. Apply excess release paste to the outer edge of the second wooden circle. Make sure not to pour excess paste on the inside of the wall of the mold. Fix the second wooden circle and clean the excess release paste.

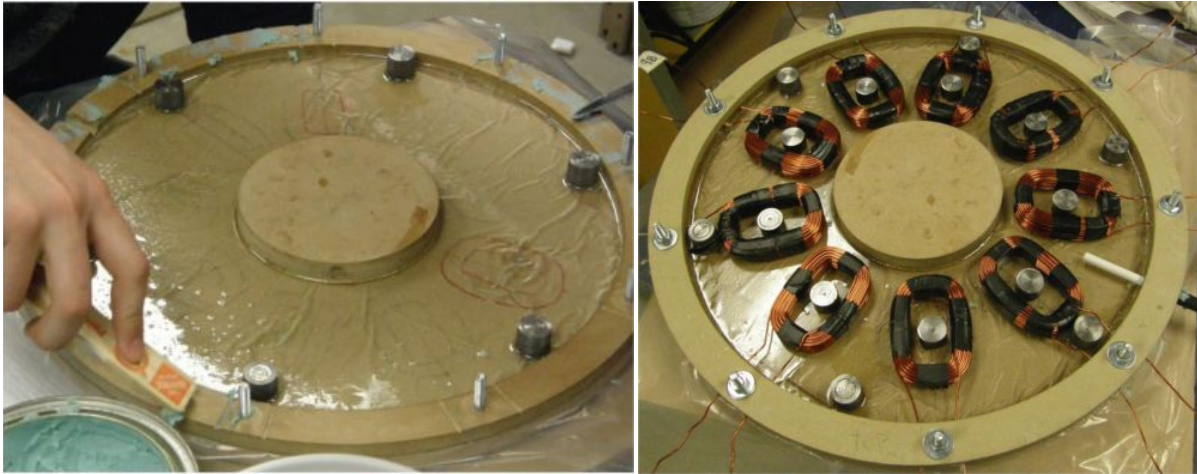

N. Check the quantity of vaseline on the tops of the pins and bushings that are not in the cast. Add more to cover if necessary to seal these areas against epoxy spillover.

O. By mixing as shown above pour epoxy into the mold until the level reaches just below the top of the mold (the second wooden circle)

P. Place a flat board that has been prepared with mold release on top of the mold, letting it rest on the center plug and the second wooden circle. Weight the board with anything available. This layer of epoxy will set up very quickly because it is thicker and it will level the surface of the mold. The board can be removed in roughly three hours.

### Demolding

Q. You can demold in 24 - 48 hours, but to be sure, let the mold dry 4/5 days.

Demold in 24 - 48 hours, but let fully cure for four to five days.

R. You can polish the top side (the bottom one will be smooth because of the film) with emery until a smooth level is reached.

Note: You may obtain a slightly thicker or thinner stator. You can either adjust the thickness of the rotor flange, or the thickness of the rotor plates.

## 16. Stator wiring

Three-phase alternators can be wired in two configurations: Y-configuration or delta. We chose to wire our generator in delta in order to produce higher voltages and attempt to keep the current in the phases down. This means that each phase is wired in series:

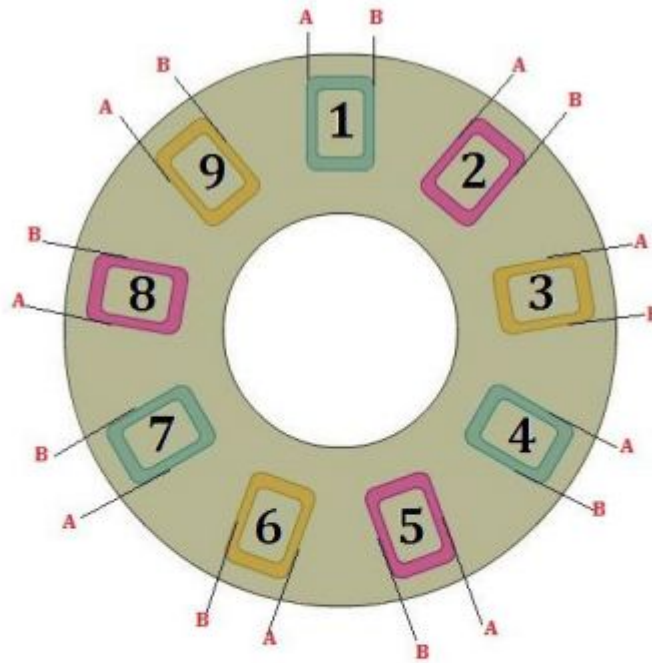

Phase 1			
Red Lead to 1A	1B to 4A	4B to 7A	7B to Ground
Phase 2			
Blue Lead to 2A	2B to 5A	5B to 8A	8B to Ground
Phase 3			
Green Lead to 3A	3B to 6A	6B to 9A	9B to Ground

The first column of the table (1A, 2A, 3A) should just have lengths of wire soldered onto them. Each phase is colored differently in order to distinguish them easily later. The next two columns show which leads to connect with pieces of wire, for example 1B should be soldered to 4A and then 4B should be soldered to 7A. The last column shows which leads to solder ground wires to (7B, 8B, 9B). This arrangement wires each phase in series and brings the power out of each phase individually.

The three phases can be utilized in many ways but based on our production we are going to rectify the signal.

## 17. Air gap optimization

The air gap represents the space between the front of a rotor and the front of the stator, on each side. If the casting is properly done, you have very little space to adjust. The magnetic potential will highly depend on this space as it is fairly easy to fall off across the air and the performance of the generator will vary.

When assembling the generator, you can easily optimize the gaps. Once you establish the final position of the stator, you can cut tension spacers and in the end replace the all-thread with high strength bolts. If the gap is too small, take extra care to ensure that the rotors are not hitting the stator in any point.

## 18. Rotor mount (flange)

The flange will be attached to the rotor plates. You need to mount them face to face. The flange also needs to have the same 4 holes drilled to align with the rotors. The tube must have the same diameter as the central hole of the rotors.

The rotor mount is built from aluminum because it is resistant to corrosion and it is light. Alternatively, it can be built from a different material.

A piece of appropriately sized steel or aluminum tubing can have a steel or aluminum ring welded to it. If this is done, one must be careful to weld evenly so that rotating balanced is maintained. The thickness of the rotor mount should match the thickness of the stator. So you need to build it after the stator is cast to determine its proper size.

To attach the flange to the shaft, two bolts can be used. Have them placed at 90 degrees to one another for a better grip.

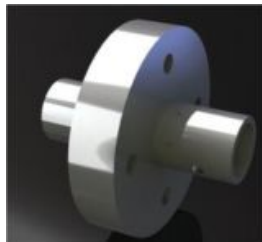

## 19. The driveshaft

The driveshaft is the metal bar that holds the flange and bearings. This element will spin at a high rate so take extra care when choosing the materials. We suggest stainless steel because of its resistance. At the end of the driveshaft (the one towards the



collar) place a handle. Further explanations will be presented. You can manufacture any type of handle as long as it gives you leverage to make the driveshaft spin.

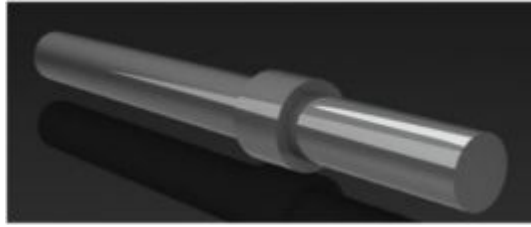

You can also use carbon steel if available because it is also resistant. Regardless of the material you will use, Permatex Anti-Seize (or similar) and caution should be exercised when assembled to prevent galling and corrosion.

You need to drill holes for the support of the flange to properly assemble and securely lock them together.

## **20. Bearing selection**

The bearings you need to use are simple flange bearings that you may have lying in your garage. We opted to use a collar onto the driveshaft that is fixed to the back of the bearing. The bearing's role is also to set the distance between the bearings.

## **21. Casing**

The whole generator will have a casing to protect its elements. This casing is crucial when using the generator in extreme conditions, such as snow, rain, etc. The case can help protect against everything from ice buildup to organics buildup to animal strikes. If implemented properly, it may be able to extend the life of the generator and help prevent corrosion of the assembly and wear on the bearings.





## 22. Implementation of the case

The case is shown here sitting with one of the end caps (before the end cap had been drilled). It is made from thin aluminum sheet and attached at the top and bottom to two aluminum boxes. They were folded out of remaining aluminum sheet and riveted together. The box which you can see inside of in the photo is actually the bottom box. It has Dzus connectors which provide quarter-turn access. Also, the fasteners stay in the material so there is no way to lose them when you open the case. The case attaches to each side of the top box via hinges. This allows each side of the case to be opened separately. The boxes will be bolted to the inside face of each end cap. Antichafe tape will be used on all edges that come in contact with the generator to facilitate a strong seal and prevent vibration noise and wear. To get the rounded shape of the aluminum shown here, use a roller setup or carefully hand roll it yourself around a mandrel of similar size.

### Tension spacers

The tension spacers are the tubes wrapped around the mounting bolts. They set the distance between the stator and the rotors. They should be placed as close as possible, but be careful for the rotor and the stator not to touch. A strong but nonferrous material (brass/bronze/aluminum) should be used. This is the moment for the air gap adjustment.

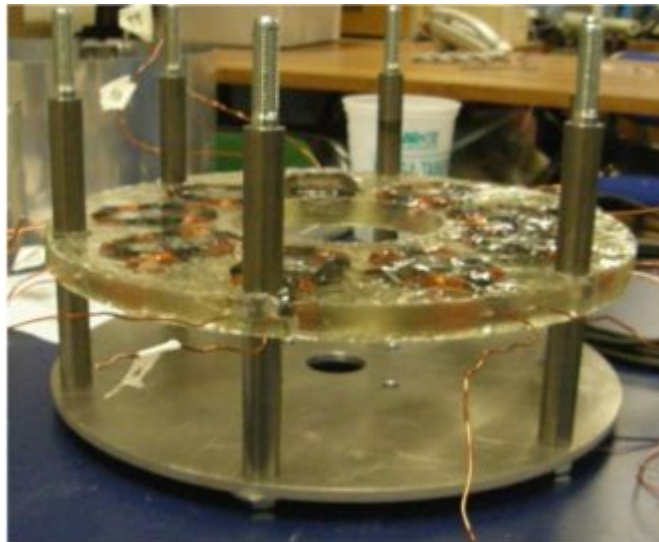

## Generator assembly

Next we will present the assembly of the generator:

1. Fix the bearing to the end cap and slide them together through the driveshaft until it fixes onto the collar. Tightly screw the system together.

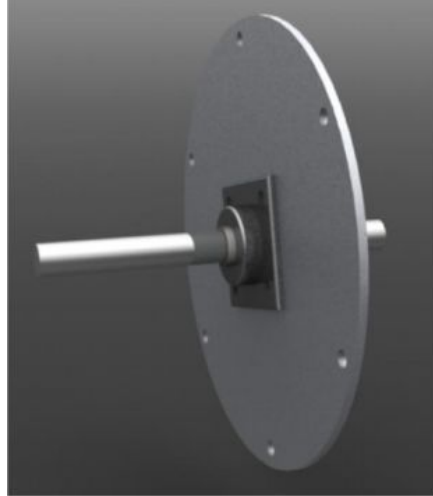

2. Next slide the first rotor plate (on the backside) then the flange and fix them together using the 4 bolt pattern. Consider using anti-seize or similar to prevent galling. Insert the locking pin into the flange to fix it to the driveshaft.

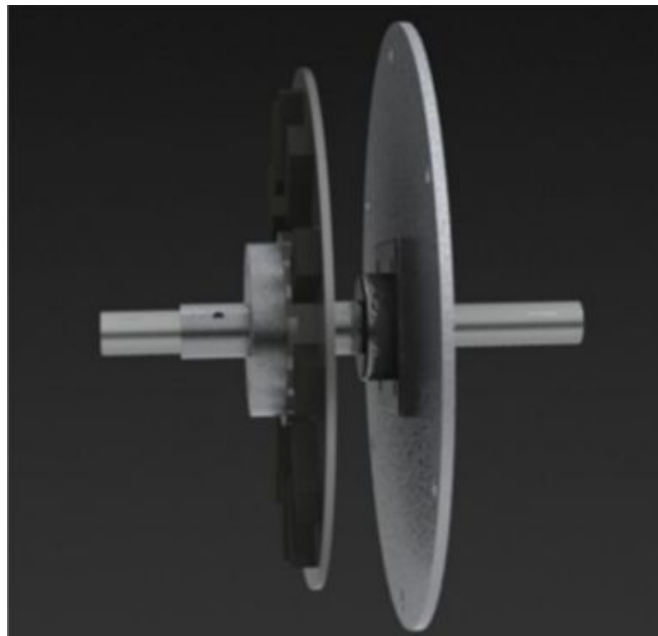

3. Place the stator onto the first rotor plate. Make sure that the rotor does not come in contact with the stator. If still not suitable, readjust the distance of the tension spacers.

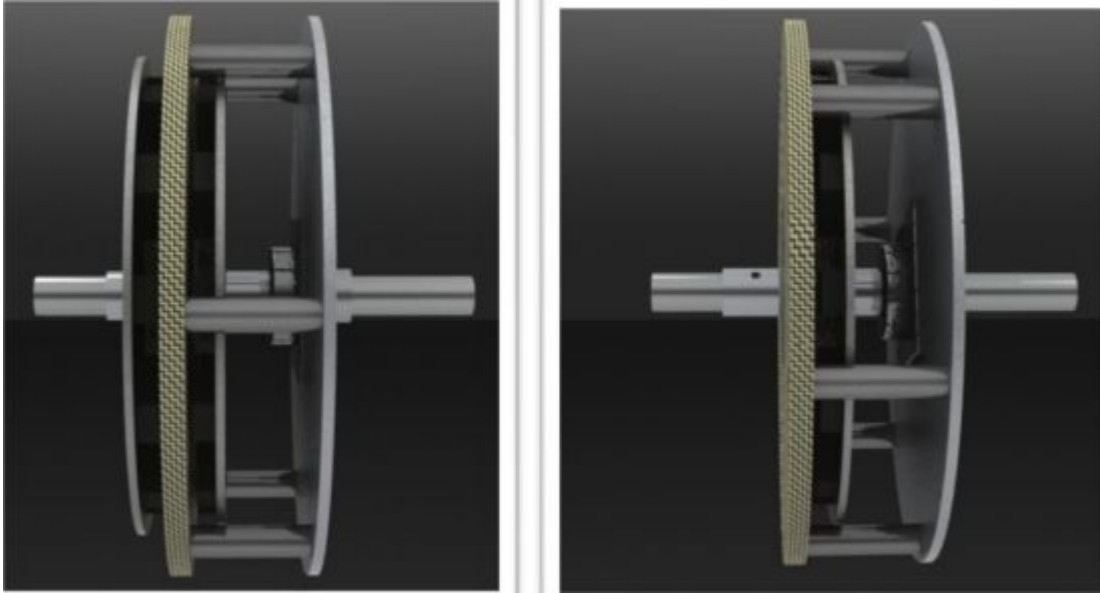

4. Next, place the second rotor plate facing the stator. Make sure the position of this stator plate is accurate because it is crucial for the magnets to attract to one another. Be very careful at this step because injury may occur. It is recommended to find a system of lowering the second plate into place, such as using wedges or small jacks. We used pieces of wood stuck in at 90 degrees and set the plate on. Then we inserted thinner pieces of wood next to them and pulled the larger ones out, thus slowly lowering the rotor. This was repeated until the rotor was in place.

5. Place the rest of the tension spacers and fix the back bearing. Fix it in place with the set screws, similar to the first bearing.

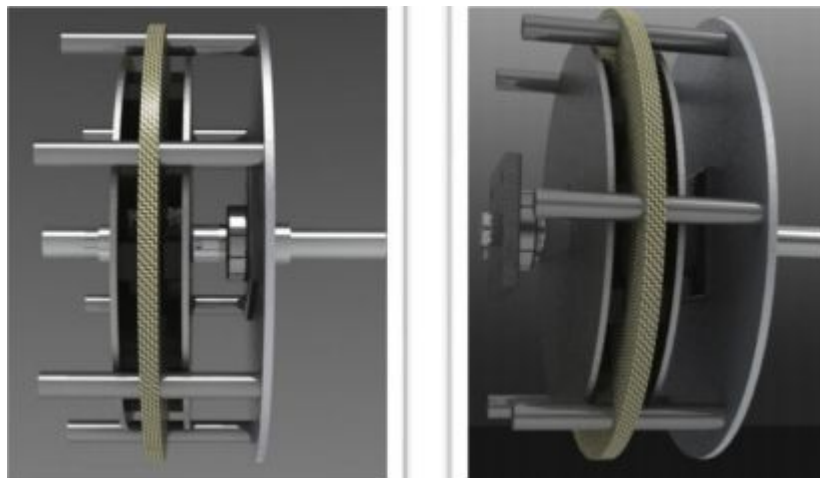

6. Place the second end cap and fix it to the bearing using the bolts.

7. Place the cast over the generator.

You now have the complete generator that can be attached to the small rotor.

## The switch

The best switching arrangement has been to use a mechanical switch which acts as a single pole changeover switch mounted on the shaft of the motor (and electrically insulated from the shaft).

First, the switch connects the battery Plus through to the Plus of the motor, causing it to rotate, as the battery Minus is permanently connected to the motor Minus. Current then flows from the battery, through the switch and into the motor

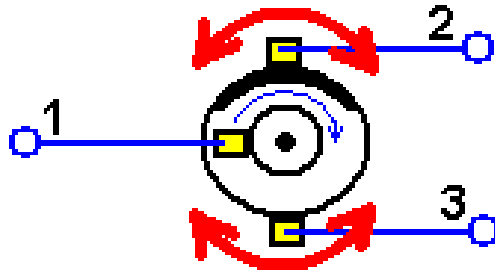

Then, just before 180 degrees of rotation have occurred, the switch opens and then connects the generator output through to the motor, with current flowing in the other direction through the switch.

## The inverter

A power inverter, or inverter, is an electronic device or circuitry that changes direct current (DC) to alternating current (AC).

The input voltage, output voltage and frequency, and overall power handling depend on the design of the specific device or circuitry. The inverter does not produce any power; the power is provided by the DC source.

An inverter converts the DC electricity from sources such as batteries or fuel cells to AC electricity. The electricity can be at any required voltage; in particular it can



operate AC equipment designed for mains operation, or rectified to produce DC at any desired voltage.

The inverter will hook up to any 12 VDC battery and step up voltage to 115 VDC and then converts that 115 VDC to usable 115 vac x 60 hz, some are pure sine wave just as what is running into your home and some are modified sine wave inverters. You can run lights, TV's, VCR's, DVD players, etc...

## Battery

You can use a Batcap or other kind of battery with capacitors

The battery used in this project is a Batcap. It seems important to use a Batcap battery or one with capacitors and not a battery with chemical storage of the energy.

A battery made of capacitors can charge and discharge a lot faster than other types of batteries.

You can try to use normal batteries, but it seems difficult to use because of the high resistance to load.

Normal batteries needs a lot of time to load.

You would also need a charge controller to control the load of the battery and to limit the power pushed in to the battery otherwise the battery would not last long.

You can use normal batteries but you would need more batteries.



## Conclusion

To conclude, the best ways to reduce energy consumption is right under our noses. This device highlights how easy it is to fight against Big Energy with a simple method in a century of rapidly changing environmental and economic conditions.

If more and more methods like this one would be available to the public, the energy crisis would cease to exist and we believe we would live in a better world.

## List of tools

### *Multimeter:*

A Digital multimeter is ok but we highly recommended to use an Analogue Amp Meter, which goes up to 1 amp or more. You will also need the meter to measure your thermoelectric modules as well as your battery voltages.



### *Soldering Iron:*



The Soldering iron will be used to solder the wires. The wires will still operate if the connections aren't soldered, though once you are sure it is wired correctly, you should solder all the connections.



*Drill press:*



*Measuring tape:*



*Gripper*



*And of course:*

Patent, screwdriver, wrenches, knife and cutter

